

**HUMAN  
WORKSPACE**

**TRESTON**

# Catalogue 2026

INDUSTRIAL FURNITURE  
AND WORKSTATIONS



WORKSPACES FOR HAPPIER WORKFACES

Design your own workstation or trolley and view it in 3D

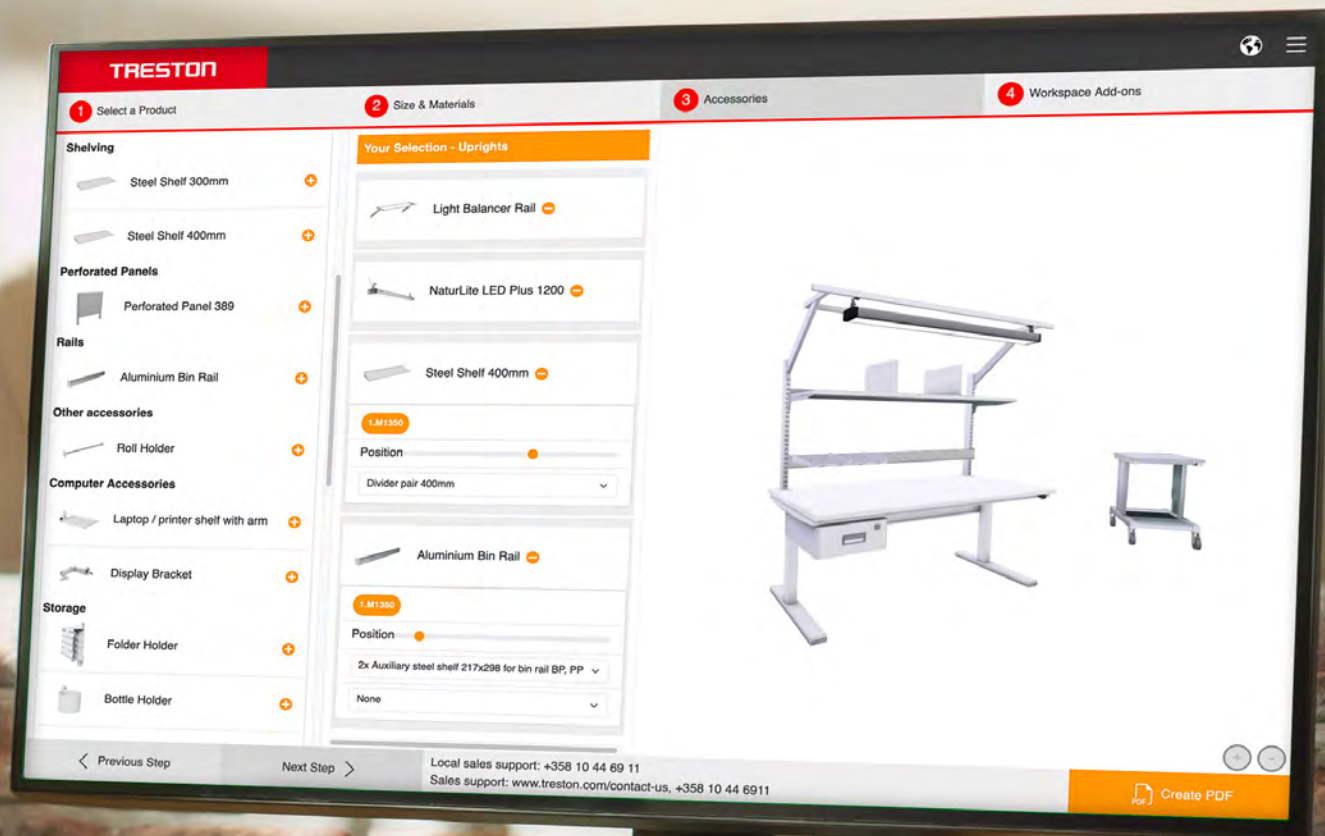

# ONLINE 3D

# CONFIGURATOR



**Improved user experience with our enhanced 3D Configurator!** The latest version boasts a suite of enhancements, ensuring a more intuitive, user-friendly, and visually appealing experience.

To get started, all you need is a mobile phone or a computer with internet browser; no downloading is required and using the software is free of charge.

# Workspaces for happier workfaces

<b>About us</b>	<b>4</b>
Industrial ergonomics	6
ESD Proof by Design™	13
LEAN thinking	16
Customised workstation solutions	18
Our sustainability approach	20
Our standards and warranty period	21
Decorating with colour	22

<b>1. Workbenches</b>	<b>23</b>
Concept Ergo - the most versatile workbench	26
WB - aesthetic and easily adaptable	32
QuatreX - 4-legged electric workbench	36
TED - electric desk for industrial use	40
PowerX - powered mobile workstations	44
Quick Edge - extremely fast height adjustment	48
TP - ideal basic workbench	50
TPH - standard workbench with one shelf	56
TPB - efficient packing bench	60
Industrial workbenches - for heavy industry	62

<b>2. Workbench accessories</b>	<b>68</b>
Concept Ergo, QuatreX, TED, Quick Edge, TP, Industrial workbenches	69
WB and QuatreX	85
TPH and TPB	90
Accessories that suit all benches	95
Packing material roll stands and cutters	100

<b>3. Lighting</b>	<b>102</b>
--------------------	------------

<b>4. Chairs</b>	<b>109</b>
------------------	------------

<b>5. Trolleys</b>	<b>116</b>
Ergonomics for manual handling of loads	118
Universal trolley WTR	124
Treston Industrial Multi trolley	125
Adjustable trolley TRTA	128
Reel holder trolley RRT	129
Mobile workstations	130
Trolleys for additional workspace	131
Packing trolleys	132
Heavy-duty trolley	134
Fitter's trolley	135
Tool trolley	136
Bin and cabinet trolley	138

<b>6. Drawer units</b>	<b>140</b>
Drawer units 35	142
Drawer unit 45	144
Drawer unit 53	148
Drawer unit 70	154
Drawer unit 90	158
Drawer unit 130	162

<b>7. Storage systems</b>	<b>166</b>
Shelving cabinets	169
Industrial cabinets	172
Personal safety and computer cabinets	175
Shelving system	176
Heavy shelving system	179
Perforated panels	182
FiFo Flow Rack	185
Tool storage systems	188
Panel hooks	192
Small-parts storage cabinets	199
Spacemisers for small-parts storage cabinets	201
Storage bin cabinets	202
Spacemisers for storage bin cabinets	203
High density storage cabinets	204
Shelf bins	205
Stacking bins	210
Storage and picking bins	213
Small drawers	214
Stacking bin racks	215

<b>8. Spare parts</b>	<b>218</b>
-----------------------	------------



**TRESTON**

WORKSPACES FOR HAPPIER WORKFACES

**HUMAN  
WORKSPACE**

# WORKSPACES FOR HAPPIER WORKFACES

There's no way around it. Sustainable long term business success in every industry is founded on empowered, motivated and healthy employees, and hyper adaptability to constant change.

The solution is simple.

A smart industrial workspace that adapts flexibly to the needs of the individual and the constant changes in the process. A next generation workstation and material flow solution that drives better business performance, environmental performance and personal performance by integrating and optimizing all work phases into a leaner, cleaner and greener process.

With decades of experience, in depth understanding of ergonomics in industrial environments, unmatched ESD competence and proven LEAN knowhow we at Treston are in a unique position to help our customers in keeping their business and people in good shape.

## **Workspaces for happier workfaces.**

This is our aspiration. This is our promise. This is what Treston is all about.





**600,000+** workstations  
delivered

**50+** years of ergonomic  
workspace development and  
manufacturing

**30+** countries,  
global footprint

# Industrial ergonomics



Have you paid attention to the methods of transferring objects, the placement and accessibility of tools, the opportunities to perform one's work either sitting down or standing up, and lighting at your workplace? All of the above are part of ergonomic workstation design, and companies that have paid attention to these have been able to significantly improve their productivity.

However, good ergonomics means more than the ability to adjust a workstation's furniture. Improving ergonomics requires knowing the work process from start to finish, but most importantly, identifying the individual needs of the job and the employee. Developing the working environment and working methods pays off, as it helps the company reduce the amount of sick leave and the number of accidents at work, improve the quality of work, and increase efficiency and production volumes. Employees who work in a pleasant environment are more energetic and productive.

## DEFINITION OF ERGONOMICS

"The word ergonomics — "the science of work" is derived from the Greek *ergon* (work) and *nomos* (laws). Ergonomics (or human factors) is the scientific discipline concerned with the understanding of interactions among humans and other elements of a system, and the profession that applies theory, principles, data, and methods to design in order to optimize human well-being and overall system performance."

# Why should you invest in ergonomics?

**Musculoskeletal disorders (MSDs) affect most employees.** According to European Agency for Safety and Health at Work musculoskeletal disorders (MSDs) are the single largest occupational health hazard in Europe: up to three out of five employees report musculoskeletal symptoms. In addition, Confederation of Finnish Industries has reported that employees in the industrial sector have the most absences due to sickness, on average 16 working days per person/year.

**Proper ergonomics can reduce MSD-related absences and improve productivity resulting in significant annual savings.** A study estimating the effectiveness of ergonomics interventions revealed that musculoskeletal symptoms and disorders were reduced 57% and absences due to MSDs reduced 72% as a result of measures that improve ergonomics. The above mentioned study on the effectiveness of ergonomics interventions concluded that productivity improved 46% through measures that improved ergonomics.

Indeed there are several aspects that proper ergonomics can have a positive impact on in the long run. The benefits of proper ergonomics are both for the employer and for the employee.

## Benefits of ergonomics to the EMPLOYER

- Improves occupational safety and reduces sickness absences
- Improves employees' performance
- Reduces occupational health care costs
- Increases productivity and efficiency
- Motivates and engages employees

## Benefits of ergonomics to the EMPLOYEE

- Improves employees' health and well-being
- Healthy and safe working environments promote the ability to work and also have a positive effect on the ability to function during leisure time
- More satisfaction for your work

Discover your workspace's hidden savings with ErgoSavings calculator!

Treston's ErgoSavings Calculator is a user-friendly tool that lets you explore the benefits of ergonomic workspaces in a tangible way. By analysing key factors like reduced injury rates, and potential cost savings, it highlights how much your company stands to gain from ergonomic investments. The default values in the ErgoSavings Calculator are based on comprehensive research and real-world data.



Try the [ErgoSavings Calculator](#) to see the financial impact of a healthier, more productive workspace



# How to improve the ergonomics of your workspace?

Below you will find a list of the five key factors that you can use to improve the ergonomics of your industrial workstations.

## 1. Have everything you need close by

When sizing your workstations, make sure that the necessary equipment and furniture are right where they need to be. This includes ensuring that there is sufficient space for various work tasks and that you can easily switch between each task. Remember to pay attention to the purpose of each workspace, as a functional and efficient space is also a safe one.

When planning the layout of your furniture and equipment, ensure that all the devices and materials you need are readily available and easy to reach. Any infrequently used materials can be stored on a shelf or auxiliary top or in a drawer, for example. A carefully planned workspace is also a productive one.

## 2. Have enough adjustable lighting at your disposal

Your eyes are just as sensitive to your working conditions as the rest of your body. That's why you need to be able to adjust your lighting to each task at hand. Make sure that sufficient lighting is available for each work phase and task. Any tasks that demand a great deal of accuracy for longer periods of time, such as quality control or assembly work, usually require lots of light as well.

When your light source is both sufficiently powerful and correctly directed, it can provide the lighting and contrast you need – regardless of personal preference or the accuracy demanded by each task.

## 3. Handle your loads carefully

You may think that lifting a 20–25 kg package does not sound like much of a challenge, but manually handling even these types of smaller loads can result in back problems and many other adverse effects to your health. In general, the manual handling of loads represents a major occupational risk that can lead to injuries to the lower back and shoulders. To ensure the health, safety and efficiency of you and your employees, pay particular attention to how loads are handled at your place of work.

To guarantee the efficiency and ergonomics of your workplace, choose the right trolley or mobile auxiliary top for transporting any larger loads, and instruct your employees on the correct techniques for handling loads.

## 4. Adjust your working posture regularly

Make sure that you vary your working posture throughout the day. It's never a good idea to remain in the same position all the time, no matter if you're seated or standing - so remember to change your working posture frequently. The latest cognitive research has demonstrated the benefits of regularly varying your working posture. According to the research results, even small movements, such as standing up occasionally, can help improve your memory, attentiveness, learning and overall cognitive performance.

## 5. Remember to adjust your chair

A chair that is designed for ergonomic working postures forms a vital part of any well-functioning, ergonomic and user-friendly workstation. Proper sitting techniques will allow you to work efficiently, reduce the risk that you will neglect to vary your posture, and permit you to operate in a way that is best for you and your work. However, an ergonomic chair is not truly ergonomic until it has been adjusted to the needs of the person using it – so remember to adjust the chair and not the employee!



Watch this animation: [6 ways to improve your workspace ergonomics](#)

## Free e-book: "Increasing productivity with proper ergonomics"



This informational e-book will help you learn how ergonomic environments can have a direct influence on employee well-being, the reduction of time and waste, and ultimately, greater productivity.

[treston.com/catalogues-and-brochures](http://treston.com/catalogues-and-brochures)



# Seated or standing work?

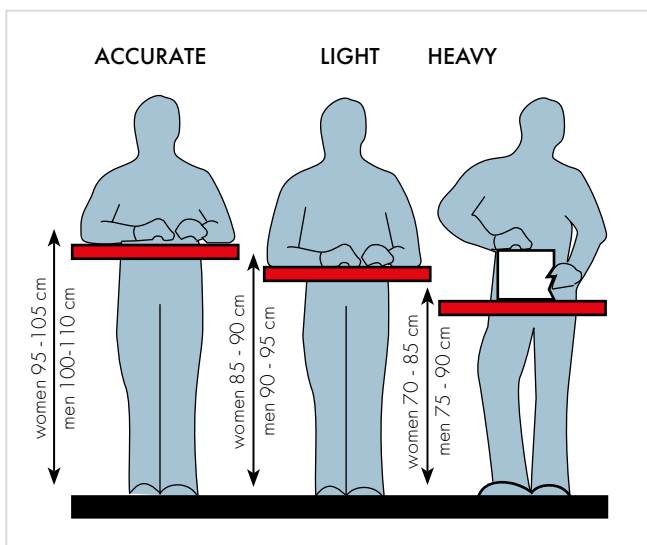

The choice of a seated or standing working position is dependent upon the task to be executed. The height of the work surface is determined by such factors as size and weight of the part, precision requirement, assembly process, repetitiveness etc.

Height adjustability is especially useful when the size of the products being handled varies or when several people use the same workstation.

## Standing work

Task	Primary choice	Secondary choice
Lifting the weight over 5 kgs	Standing	Semi-sitting
Working below the elbow level	Standing	Semi-sitting
Need to reach widely in horizontal level	Standing	Semi-sitting
Light assembly work	Sitting	Semi-sitting
Precision work	Sitting	Semi-sitting
Visual monitoring or supervising	Sitting	Semi-sitting
Need to move between workstations	Semi-sitting	Standing

**Semi-sitting**  
*between sitting and standing; reduces the strain of the back due to sitting and the strain of the lower limbs due to standing.*



# Reaching distances and heights

To improve working postures in assembly work, the most often used parts should be placed into the optimal horizontal working area within the operator's sight. Avoid overly large or deep workbenches, which can cause improper reach and reduced productivity. Assembly work is most ergonomic when parts are within easy view and reach.

The vertical work area and reach zone can be fine-tuned with accessories. Our height adjustable arms optimize work movements and keep parts or tools within easy access. Operators can work with wrists and arms in optimal posture with shoulders relaxed. Tilted bin rails and shelves keep the wrist in a neutral position when picking parts. The tilt angle also provides easy identification of the parts with the proper viewing angle.

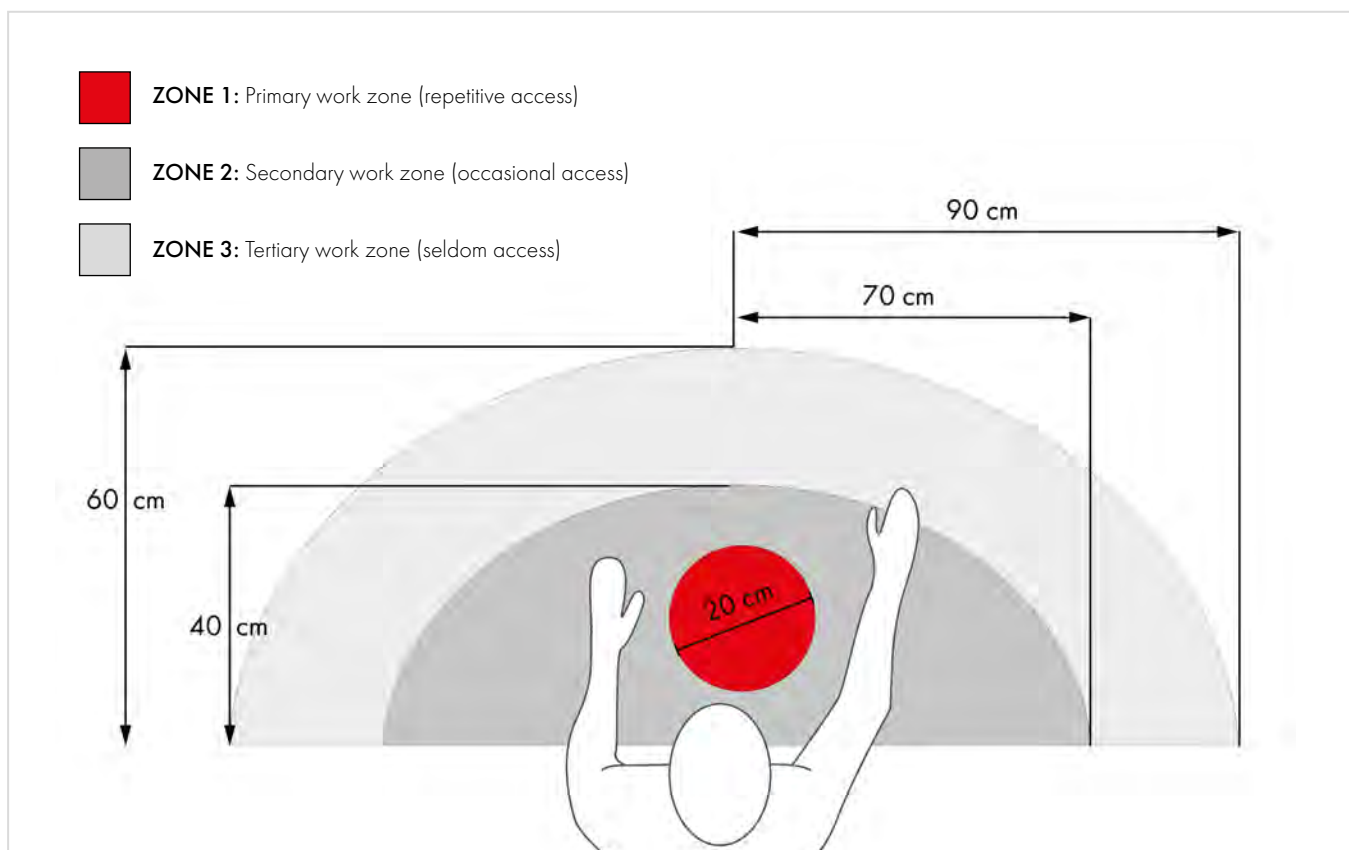
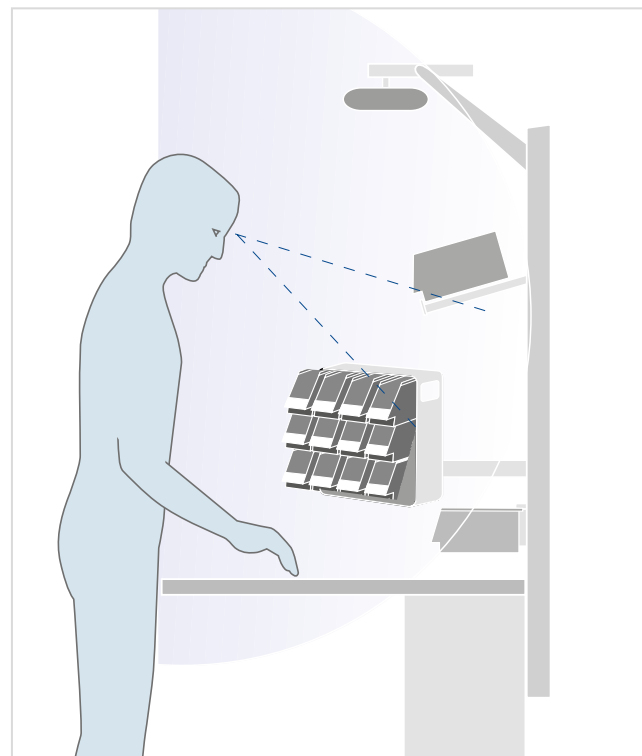

Ergonomic workzones

# Treston ErgoID™

Identify. Improve. Thrive.

**Visualise and Optimise Your Workplace Ergonomics with AI.** Utilising AI computer vision software, we examine your workflow, identify risks and craft a tailored action plan to improve your environment's ergonomics.

- Reduce costly sick leave
- Improve productivity and worker satisfaction
- Quick and easy assessment process
- No interruptions for workers

Treston ErgoID® uses secure AI software, powered by TuMeke Ergonomics, to analyse working positions, applying recognized standards like RULA, REBA, and the NIOSH lifting equation.



[treston.com/ergo-id](https://treston.com/ergo-id)



## Why Choose Treston ErgoID™?

**Expertise in Industrial Ergonomics:** Our team of specialists, backed by years of experience and ergonomics training, collaborates with advanced AI software, powered by TuMeke Ergonomics, to offer personalised recommendations. We gather key ergonomic data, evaluate posture, equipment placement, and movement patterns, and provide detailed insights into your workspace ergonomics.

**Leading Supplier of Ergonomic Furniture:** With over 50 years of experience, we understand the unique challenges of industrial workplaces and make expert recommendations for proper ergonomic practices.

**Virtual or On-Site Ergonomics Training:** Choose from virtual or on-site training led by our experts to learn practical techniques, receive tailored guidance, and access resources for creating a healthier and more productive workspace.

**Cost-Effective Introduction to Ergonomics:** Treston ErgoID® provides a less expensive and less intrusive alternative to wearable technology or ergonomic consultants, making it an ideal first step for companies looking to improve workplace ergonomics.

**Maximising Your Ergonomic Investment:** We empower employers and employees to identify poor ergonomic conditions and understand how to utilise their workstation properly in order to maximise their investment in ergonomics.

Work smarter, not harder

# ESD Proof by Design™



Manufacturing or handling electronic components and products requires protection from ESD, electrostatic discharges. Even the smallest ESD can cause major damage to sensitive components, weaken the end-product's durability, or change its functionality. Costly ESD damages can be avoided by building an ESD protected area (EPA) where ESD workstations play a crucial role.

At Treston, ESD protection is built into the very foundation of our ESD workstation solutions. All our high-quality and ergonomic workstation furniture is available as ESD-protected versions. For over 40 years, Treston has been the benchmark in ESD furniture because we create workspaces where safety, comfort, and performance go hand in hand.

**Treston's ESD workstation solutions are ESD Proof by Design™.**



## Compliant and certified

- Compliant with international ESD standards, IEC 61340-5-1, IEC61340-6-1, and ANSI S20.20.
- You can focus on performance, not compliance worries.



## Safe, reliable, proven

- Treston has been the benchmark for ESD workstations for over 40 years.
- Innovative conductive ESD paint reduces the need for separate grounding, creating cleaner, safer and more efficient workspace.
- Our high-quality products have a 10-year warranty.



## Versatile products and services

- Comprehensive ESD product range with over 300 workstation accessories
- Modular solutions - designed to adapt, scale, and grow with your needs.
- Holistic ESD knowledge and extensive global customer support helping from consulting and planning to after-sales support

# Terms and explanations

<b>ESD</b>	<b>Electrostatic discharge.</b> Occurs when two electrically-charged objects come together and a charge is discharged. Could result in either immediate or latent damage to an electrical component
<b>ESDS</b>	<b>Electrostatic discharge sensitive.</b> A component that needs ESD protection.
<b>EPA</b>	<b>ESD-protected area.</b>
<b>Conductive material</b>	<b>Conductor</b> = material that permits electricity flow. Metals are often conductive, e.g. copper and aluminium.
<b>Insulating material</b>	<b>Insulator</b> = material that does not conduct electricity. The insulator can be electrostatically charged. Insulators can be plastic or wood, for example.
<b>Standards</b>	<b>IEC 61340-5-1:</b> ESD standard widely used in Europe and ANSI S20.20 in the Americas. Both standards have a great number of similarities.

## ESD - Electrostatic discharge

In ordinary movement a person creates static electricity. In these circumstances hand contact with a conductive material will discharge static from the body very rapidly. This is ESD = Electrostatic discharge. Static electricity has become a major problem in the electronics industry. Usually this passes unnoticed because our bodies do not feel discharges below 3000 volts. We may see ESD above 5000 volts as a spark.

The most sensitive components may be damaged by a charge of just 30 volts, and many standard components

are sensitive to charges of 100...200 volts. The presence of inherent ESD is not easy to detect. Product-related defects can often be latent and become active over time. An unbroken ESD safety chain is essential to guarantee the quality of the final product. An ESD-protected production chain is called an EPA (= ESD Protected Area). Employees must be able to implement the right policies in an ESD-protected work environment.

### CHARGES GENERATED ON DAILY WORK ACTIVITIES

<b>Walking across a carpet</b>	1 500 – 35 000 volts
<b>Walking over vinyl floor</b>	250 – 12 000 volts
<b>Working at a bench</b>	700 – 6 000 volts
<b>Picking up a plastic bag from bench</b>	1 200 – 20 000 volts
<b>Chair with polyurethane foam</b>	400 - 3 000 volts

The lower the relative humidity the higher the voltage. The lowest values in the table usually apply when the relative humidity is 65-90%. During a cold winter day, the relative humidity in indoor spaces can be as low as 10 %.



Watch this video: [ESD workstation management](#)

# Investing in an EPA is important

There are two types of ESD damage in industrial and technical environments. Firstly, a fatal defect that is usually easily detected during assembly or handling, or at least through careful testing. Such products are usually not delivered to customers. Secondly, another type of ESD damage is latent damage. This is difficult to detect with bear eyes and the product may pass all tests and function normally for some time. However, latent damage affects the performance and durability of the product and often results in poor product quality.

## Static charge management of working area:

- ESD-protected workstations. Attention paid to ESD safe storing, moving and packing.
- Personnel protected with shoes, wrist straps and other needed accessories
- Staff training, work instructions and quality control
- Cleanliness of ESD-protected equipment. Dust and dirt insulate.
- Commitment to continuous improvement in static electricity management



[treston.com/catalogues-and-brochures](http://treston.com/catalogues-and-brochures)

## Example of an ESD-protected area (EPA)

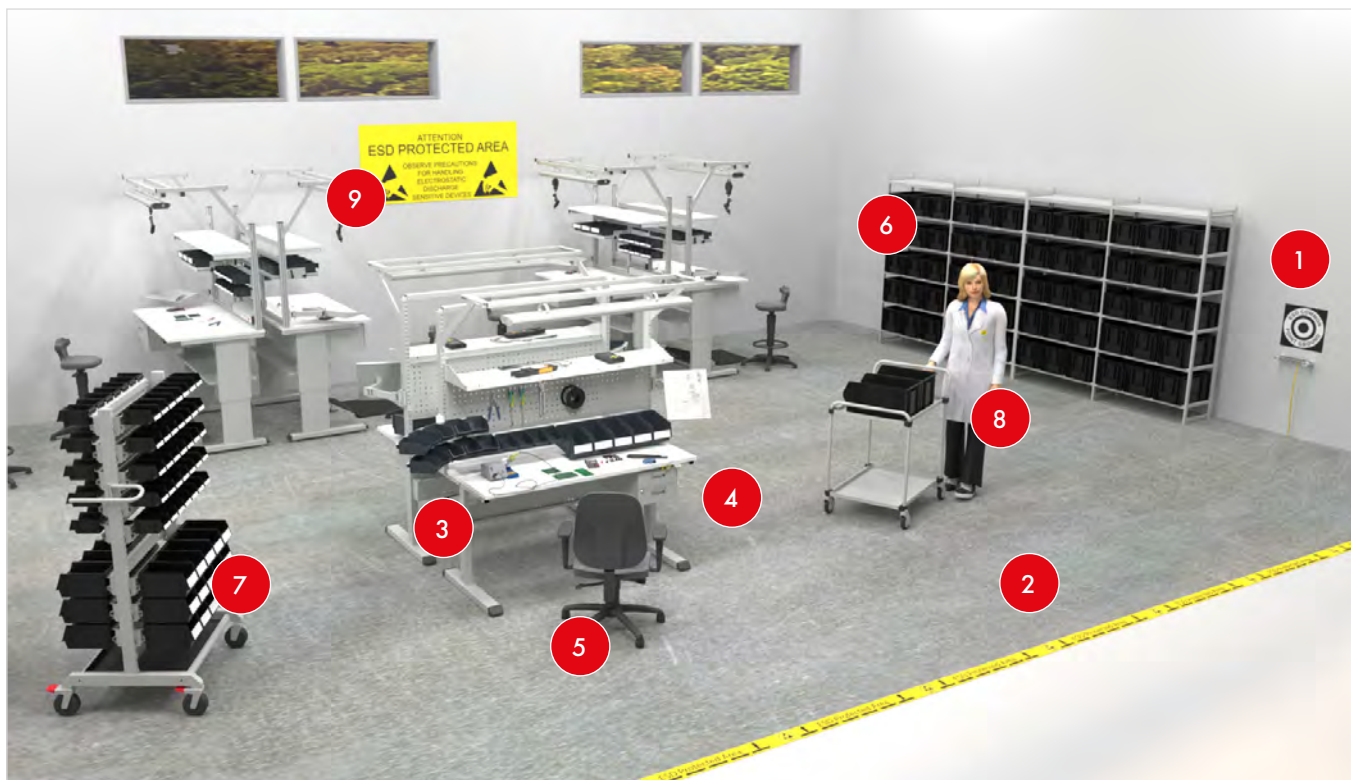

1. Common point ground  
2. ESD floor  
3. Semi-conductive table

4. Wrist strap + earth bounding point  
5. Chair with ESD castors  
6. Semi-conductive ESD shelf

7. Trolley with ESD castors  
8. ESD garments (e.g. jacket and shoes)  
9. EPA sign

Work smarter, not harder

# LEAN thinking perfects production processes



Developed in the Japanese automotive industry, Lean is an operating philosophy that helps to make production smooth and efficient. Lean-based production processes and workstations are functional and task-oriented. Every item in the workstation has its own designated place, and there are no unnecessary items.

When developing operations, instead of focusing on a single task or workstation, it is better to consider the big picture and identify areas where work, time or materials are wasted. In practice, Lean involves the entire process,

including the overall order-supply chain. The Lean system is everything that adds value for the customer and helps put things in the right order. The goal is to eliminate anything that does not add value. When organising workstations according to the Lean system, the first job is to identify

- what is the product that is being made,
- what are the customer needs, and
- what is the pace at which the product needs to be manufactured.

## Free e-book: "LEAN thinking perfects production processes"



This e-book will help you understand LEAN philosophy and how Treston, as a manufacturer of technical facilities and ergonomic furniture, can help you with the LEAN thinking to perfect your production processes.

[treston.com/catalogues-and-brochures](https://treston.com/catalogues-and-brochures)



# Treston's ergonomic solutions for Lean and 5S environments

**Full-time employees spend around 40 hours a week at their workstations, adding up to around 1700 hours a year.** Employees typically spend more of their waking hours at their workstations than at any other single place. Workstations are therefore important places. They should be designed not only extremely functional from a point of view of increasing efficiency but also to be ergonomic, pleasant and comfortable to work. Designing workstations according to the principles of ergonomics and LEAN bring the best benefits to employees, employers and customers.

Ergonomic and hyper-adaptable modular Treston products are ideally suited for use in Lean and 5S production processes. The open design of Treston workstations enables fast visual inspections while providing easy access to tools and components. Accessories can also be easily added, removed and interchanged, enhancing responsiveness and supporting continuity in operations. Tool holders, document shelves and bins help to keep the workstation tidy and well organized. From an ergonomics point of view, they can be positioned in just the right place for the employee to make performing the work as ergonomic and pleasant as possible.

Ergonomic, Lean-compatible workstations give employees an opportunity each day to perform to the best of their abilities.

Treston products are ideally suited for use in Lean and 5S production processes:

- 1 Adjustable workbenches and task chairs
- 2 Modular storage solutions
- 3 Ergonomic trolleys
- 4 Adjustable task lighting



# Customised workstation solutions

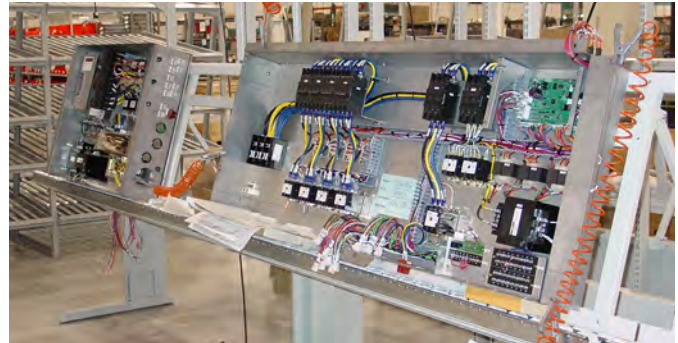
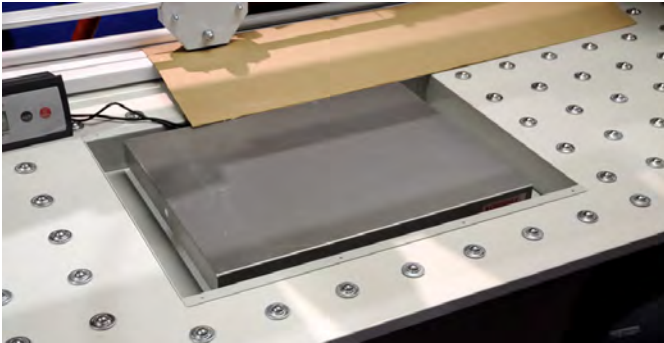

**Sometimes even highly modular industrial furniture and a large selection of accessories cannot meet all the needs of a diverse and ever-evolving working environment.**

We can answer customers' specific needs by offering modified versions of our workstations and storage solutions, or by designing a completely tailor-made industrial furniture solution made to the customer's specifications.

## Support and advise

Our skilful and helpful sales engineers are here to help you reach the optimal workspace solution, which is ergonomic and productive, and working for your long-term success. From the initiation of a project to order processing and all the way to implementation on site, we are here for you.

## Safety and ergonomics guaranteed

Treston ensures you get a safety approved and ergonomic solution. Treston's tailored solutions are based on proven concepts, and our expertise in ergonomics and ESD, as well as experienced engineering and manufacturing teams, ensure you get a risk-free solution.

## Experience from various industries and applications

We have decades of know-how in designing complete workstation solutions for a wide range of industries and applications, from electronics industry's high-tech assembly applications to the specific needs of heavy industry.

## Fast turn-around times

Over the years, we have established dedicated teams and streamlined our processes. Sales, the design team, and production all work smoothly together to deliver a fast turn-around time and the best customer experience. Our extensive product portfolio helps to get to a tailored solution affordably, and in-stock items ensure the project gets moving fast.

# Treston offers both variations and complete custom-made solutions

## Treston Lifting Platform

- Treston Lifting Platform enables ergonomic working conditions even where workbenches or existing infrastructure, such as conveyor systems or machinery, are not height-adjustable.



## A bench with tailor-made integrated FiFo system

- Treston bench with a special custom-made integrated FiFo system. Based on the versatile Concept bench model.



## A custom-made cabinet with sliding perforated panels

- A customised industrial cabinet with sliding perforated panels to give extra storage space.



**Typical modifications**

- 1 Cut-outs and designs for desktop
- 2 Different size
- 3 Different colour
- 4 Desktop with a specific ball-roller solution
- 5 Specific accessories
- 6 Integration with a conveyor line

# Our sustainability approach

## OUR VISION

Creating a more sustainable world by **Innovating ergonomic workspace solutions for industrial environments**



At Treston, we are dedicated to creating a more sustainable world through high-quality, innovative and ergonomic workspace solutions tailored for industrial environments. Our sustainability strategy relies on three key pillars:

### 1. Sustainable products and services

Includes, for example: Ongoing product development, durability and modularity, 10-year warranty, CO2 footprint calculation\*, recyclability.

### 2. Employee wellbeing

Includes, for example: Ergonomic working environments for our employees and customers, health and wellbeing, career development, employee satisfaction.

### 3. Responsible production and practices

Includes, for example: Quality & environmental management (ISO 9001:2015 and ISO 14001:2015), EcoVadis commitment, preparing for sustainability reporting: CSRD directive and ESRS reporting, manufacturing transparency, energy efficiency, water and waste management, ethical standards.

*\*In the year 2022 we started to build our internal expertise on CO2 calculations. These insights help us identify and improve the most impactful aspects of our environmental footprint. In the year 2024 we reached the capability to calculate the CO2 footprint for our products. We target to offer the CO2 results for our customers and stakeholders in the year 2025.*



Read more about our sustainability approach from [treston.com](https://www.treston.com)

# Our standards comply with the highest certification requirements

## Product certification

### ESD certification IEC 61340-5-1

#### ESD workstations

Concept Ergo electric and allen key adjustable workstations  
WB electric adjustable workstations  
QuatreX workstations  
TED workstations  
TP workstations  
TPH workstations

#### ESD chairs

Treston Ergo  
Treston Plus  
Neon  
Flex  
Stool  
SADDLE

#### ESD trolleys

Multi Industrial trolleys  
SAP trolleys

#### ESD storage bins and bin cabinets

### Cleanroom suitability ISO 14644-1 class 7

Concept Ergo electric adjustable ESD workstations  
WB electric adjustable ESD workstations  
QuatreX ESD workbenches  
TED ESD workbenches  
Treston Ergo chair C20PU-ESD  
ESD bins

### GS mark issued by a TÜV inspection body

WB allen key, hand crank and electric adjustable workstations  
TPH workstations  
TP workbenches

### GS mark issued by a SGS inspection body

Lighting: TNL1 200P, TNL1 200, TNL900, TNL500W

## CE certification

CE marking is a key indicator of a product's compliance with EU legislation.

The CE mark is included in all our **electric adjustable workbenches, power rails and lighting**.

The EU Declaration of Conformity can be found in the assembly instructions along with the details of the EU directives and standards applied

## ISCC certification

ISCC (International Sustainability and Carbon Certification) ensures that our materials meet strict sustainability and traceability standards throughout the entire supply chain.

The certification verifies that the bio-based raw materials are produced responsibly and that their origin can be transparently traced (**Treston BiOX bins**)

## Management system certification

Quality certification ISO 9001: 2015

Environmental Management System certification ISO 14001: 2015



## TRESTON WARRANTY PERIOD

**The guarantee period for Treston™ products is 10 years from the date of delivery with some exceptions.**

For plastic bins guarantee is 5 years. The warranty period for worksurfaces, electric components, saddle chairs, lights, and normal wear and tear items such as castors, slides and roll profiles is 2 years. For trading products and components as well as custom-made articles we guarantee 2-year warranty unless otherwise agreed.

# Decorating with colour

Frames of workbenches, cabinets, shelving, drawer units and trolleys are all light grey RAL7035. Outside of the standard colour range, additional colours are available on request. Please contact contact a representative or email us at: sales@treston.com.

	Colour code	RAL code	Doors	Drawers	Perforated panels and back panels
Light grey	49* & 41**	RAL 7035 (ESD)	STD	A/STD	A/STD
Blue	07	RAL 5007	STD	A/STD	STD
Dark grey	45	RAL 7045	A	A	A

STD = Standard factory colour, normal warehouse delivery, listed price.

A = Factory colour, delivery 15 days from the factory, listed price.

\* The products ordered with the colour code 49 (RAL 7035) are entirely ESD protected. Please note the ESD protection feature of these colours will result in a slightly darker shade of colour than the given RAL code.

\*\*The frames of the products ordered with the colour code 41 (RAL 7035) are powder coated with a light grey ESD colour, but there are non-ESD parts in these products, such as rails, rubber mats or castors.



*Printed colours do not give a fully accurate representation of painted colours. Please ask a representative about various samples.*



**The colour code is included in those product codes that are formed with numbers.**

It is either at the end, following the hyphen (e.g. 860 804-49), or in the middle (e.g. C 334 07:000).



**Outside of the standard colour range, additional colours are available on request.**

# 1. Workbenches



## Concept Ergo workbench, page 26

- Multiple bench variations with advanced ergonomic features
- Perfectly suitable for assembly, quality control or packing environments
- Superior range of accessories, easily reconfigured
- Maximum load capacity 500 kg



500 kg



## WB workbench, page 32

- Aesthetic, ergonomic and easily adaptable to a large variety of tasks and environments
- Designed for the needs of R&D, electronics assembly and testing
- Extensive range of accessories to meet any need. Various layout possibilities from back-to-back to corner solutions
- Maximum load capacity 300 kg



300 kg



## Treston QuatreX workbench, page 36

- Electrical workbench specifically designed to offer supreme stability, flexibility, and precision
- Meets the needs of various industries and segments, including luxury goods manufacturing, electronics manufacturing, fine mechanics, logistics, and maintenance
- Flexibility and versatility – choose perforated or aluminium uprights
- Maximum load capacity 300 kg



300 kg



## TED electric desk, page 40

- TED Electric Desk comes with quick, silent and wide height adjustment
- This ergonomic sit-stand desk perfectly suits light-duty assembly work, packing applications, R&D and industrial offices
- The desk can be customized with accessories which further enhance ergonomics
- Maximum load capacity 200 kg



200 kg



## Treston PowerX series, page 44

- Powered mobile workstation series designed for flexible working environments
- When equipped with a power station, the workstations can supply power for computers, printers and other essential equipment
- Three models: Treston PowerX Move, Treston PowerX TED and Treston PowerX QuatreX



### Quick Edge workstation, page 48

- The quickest height adjustment on the market - no electricity needed
- Can be customised for various operating environments
- Multiple accessories available: swivel arms for tool holders and screens, LED lights, shelves with dividers for cartons
- Maximum load capacity 100 kg



### TP workbench, page 50

- Standard and cost-effective workbench
- Suitable for a wide range of tasks and environments
- Superior range of accessories, easily reconfigured
- Maximum load capacity up to 300 kg



### TPH workbench, page 56

- Standard and cost-effective workbench with one shelf
- Suitable for a wide range of tasks and environments
- Essential range of accessories for basic needs
- Maximum load capacity up to 300 kg



### TPB packing bench, page 60

- Safe, economic and ergonomic all-in-one packing bench
- Adapts and grows according to needs
- 50+ accessories and add-on products available
- Maximum load capacity up to 300 kg



### Industrial workbenches, page 62

- The industrial workbenches are a sturdy models that can withstand the heavy wear and tear of heavy industry
- Choose Heavy workbench or Heavy Duty workbench and build the combination that best meet your needs
- Maximum load capacity for Heavy workbench up to 550 kg, for Heavy Duty workbench up to 1000 kg



# Concept Ergo workbenches



See the ready-made configurations of the bench in our [3D Configurator!](#)

The ergonomic Concept Ergo workbench can be flexibly adapted to meet the needs of industrial working environments. Multiple sizes and combinations are available in this product family.

Modular design provides total integration with the existing system and the potential to flexibly adapt to changes in the environment. The Concept Ergo workbench has the widest range of accessories on the market, and is suitable virtually to any environment, application and industry, from electronics and luxury item manufacturing to medical equipment suppliers (cleanroom suitability ISO class 7).

Concept Ergo workbenches are available in allen key and electric adjustable versions. Hand crank adjustable version is available as old Concept model. For corner and extension solutions, please contact our sales team.



500 kg



EPA

- Multiple bench variations with advanced ergonomic features for quality control, packing and assembly environments
- Highly adaptable to various applications and the needs of the user
- Superior range of accessories for easy reconfiguration
- Excellent stability, suitable for heavy loads up to 500 kg

## ACCESSORIES ON PAGE 69

Superior range of accessories available for ergonomic Concept Ergo workstation.



Watch the feature showcase [video](#)

# Concept Ergo workbench examples



### 1. Concept Ergo EL manual assembly workstation

Qty	Name	Size mm	Code
1	Concept Ergo electric adjustable workbench frame	1500 x 750	CE15075EL-49
1	High pressure laminate bench top	1530 x 750	TT15375-HPL
1	Upright tube module, 1359 mm	2 x M750	UTM2X750M-49
1	Light and balancer rail 2xM750	1500	91849006P
1	Treston NaturLite LED	1200	TNL1200
1	Perforated panel M750	718 x 389	861511-49
1	Perforated panel M750	718 x 1003	861514-49
1	Document holder A4	290 x 330	92849008P
1	Adjustable shelf M750	720 x 505	92049005P
1	Rotating tool panel frame, height-adjustable arm	513 x 320	860864-49P
1	Perforated panel M500	470 x 300	860951-49
1	Tool trough M500	470 x 150	860952-49
1	Bin rail M750	742 x 100	859151-41

### 2. Concept Ergo ESD workstation

Qty	Name	Size mm	Code ESD
1	Concept Ergo allen key adjustable workbench frame	1500 x 750	CE15075-49
1	ESD bench top	1530 x 750	TT15375-ESD
1	Upright tube module, 1359 mm	2 x M750	UTM2X750M-49
1	Light and balancer rail 2xM750	1500	91849006P
1	Treston NaturLite LED	1200	TNL1200
2	Perforated panel M750	M750 x 1003	861514-49
1	Steel shelf M750	740 x 300	836028-49
1	Steel shelf M750	740 x 400	852770-49
1	Aluminium bin rail M750	736 x 55 x 75	BP750C
1	Laptop/printer shelf	365 x 365	93049001P
1	Curved bin rail with arm	770 x 54	92949002P
1	Extension for curved bin rail with arm	770 x 54	860911-49
1	Magnifying lamp Wave LED ESD		TWL ESD
1	Drawer unit 45/14-1		60349001
1	Drawer unit fastening set for Concept Ergo		DFCE-49
1	Earthing box		J6603

### 3. Concept Ergo EL packing workstation

Qty	Name	Size mm	Code
1	Concept Ergo electric adjustable workbench frame	1500 x 750	CE15075EL-49
1	High pressure laminate bench top	1530 x 750	TT15375-HPL
1	Upright tube module, 1359 mm	2 x M750	UTM2X750M-49
1	Light and balancer rail 2xM750	1500	91849006P
1	Roll holder M750	635	890547-49P
1	Cutting support for packing material holder		CSM750-49
1	Equipment tray	250 x 250 x 125	92849002P
1	Document shelf M750	720 x 265	860115-49
1	Tiltable top shelf TTS M750	717 x 300	TTSM7503-49
1	Divider hoops set		PDH300-49
1	Perforated panel M750	718 x 389	861511-49
1	Aluminium bin rail M750	486 x 55 x 75	BP750C
1	Auxiliary shelf	217 x 330 x 50	ASSA4
2	Fixed tape dispenser		FTD50
1	Power rail 5 sockets+switch+2xUSB	683	TPR7-001
1	Tool tray PTH	1000 x 600	PTH100
1	Pull-out steel shelf for printer	500 x 510 x 515	PSP50
1	Shelf for packing material M750	717 x 600 x 32	SPM750-49
1	Adjustable fastening set under worktop	90 x 350 x 355	SPMAF-49
1	Divider hoops set		PDH600-49

### 4. Concept Ergo manual assembly workstation with castors

Qty	Name	Size mm	Code
1	Concept Ergo allen key adjustable workbench frame	1500 x 750	CE15075-49
1	High pressure laminate bench top	1530 x 750	TT15375-HPL
2	Upright tube, 1359 mm	1359	860024-49
1	Tiltable top shelf TTS M750	1467 x 400	TTSM15004-49
1	Light and balancer rail 2 x M750	1500	91849006P
1	Treston NaturLite LED	1200	TNL1200
1	Divider hoop set		PDH400-49
1	Rotating tool panel frame, double arm	513 x 320	880865-49P
1	Perforated panel M500	470 x 300	860951-49
1	Tool trough M500	470 x 150	860952-49
2	Light bin rail M500	492 x 54	860953-49
1	Perforated panel M1500	1474 x 389	861526-49
1	Power rail, 6 sockets+switch+2xUSB	1400	TPR14-001
1	Tool holder box	400 x 300 x 150	PPH TXL
1	Drawer unit 45/14-1		60349001
1	Drawer unit fastening set for Concept Ergo		DFCE-49
1	Lower shelf ESD for Concept Ergo	1500 x 600	LSCE1500-49
1	Castor set for Concept Ergo	Ø 100 mm	LCS100CE

# Designing Concept Ergo workstation

- Select the bench frame and the height adjustment method: allen key or electric.
- Select a bench top to suit the frame: high pressure laminate laminate, low pressure laminate or ESD bench top.



**+** **Accessories from page 69**  
 Superior range of accessories available for ergonomic Concept Ergo workstation.

### Concept Ergo bench frames

Bench frame size W x D mm	Code	Code
	Allen key adjustable	electric adjustable
1000 x 600	CE10060-49	CE10060EL-49
1000 x 750	CE10075-49	CE10075EL-49
1000 x 900	CE10090-49	CE10090EL-49
1200 x 600	CE12060-49	CE12060EL-49
1200 x 750	CE12075-49	CE12075EL-49
1200 x 900	CE12090-49	CE12090EL-49
1500 x 600	CE15060-49	CE15060EL-49
1500 x 750	CE15075-49	CE15075EL-49
1500 x 900	CE15090-49	CE15090EL-49
1800 x 600	CE18060-49	CE18060EL-49
1800 x 750	CE18075-49	CE18075EL-49
1800 x 900	CE18090-49	CE18090EL-49
2000 x 600	CE20060-49	CE20060EL-49
2000 x 750	CE20075-49	CE20075EL-49
2000 x 900	CE20090-49	CE20090EL-49
Bench height adjustment	700-1100 mm	700-1100 mm*
Bench frame max load	500 kg	400 kg

\*Height adjustment speed 13 mm/ second.

### Concept Ergo bench tops

Bench top size W x D mm	Code HPL	Code LPL	Code ESD
	1000 x 600	TT10060-HPL	TT10060-LPL
1000 x 750	TT10075-HPL	TT10075-LPL	TT10075-ESD
1030 x 750	TT10375-HPL	TT10375-LPL	TT10375-ESD
1000 x 900	TT10090-HPL	TT10090-LPL	TT10090-ESD
1030 x 900	TT10390-HPL	TT10390-LPL	TT10390-ESD
1200 x 600	TT12060-HPL	TT12060-LPL	TT12060-ESD
1200 x 750	TT12075-HPL	TT12075-LPL	TT12075-ESD
1230 x 750	TT12375-HPL	TT12375-LPL	TT12375-ESD
1200 x 900	TT12090-HPL	TT12090-LPL	TT12090-ESD
1230 x 900	TT12390-HPL	TT12390-LPL	TT12390-ESD
1500 x 600	TT15060-HPL	TT15060-LPL	TT15060-ESD
1500 x 750	TT15075-HPL	TT15075-LPL	TT15075-ESD
1530 x 750	TT15375-HPL	TT15375-LPL	TT15375-ESD
1500 x 900	TT15090-HPL	TT15090-LPL	TT15090-ESD
1530 x 900	TT15390-HPL	TT15390-LPL	TT15390-ESD
1806 x 600	TT18060-HPL	TT18060-LPL	TT18060-ESD
1806 x 750	TT18075-HPL	TT18075-LPL	TT18075-ESD
1836 x 750	TT18375-HPL	TT18375-LPL	TT18375-ESD
1806 x 900	TT18090-HPL	TT18090-LPL	TT18090-ESD
1836 x 900	TT18390-HPL	TT18390-LPL	TT18390-ESD
2000 x 600	TT20060-HPL	TT20060-LPL	TT20060-ESD
2000 x 750	TT20075-HPL	TT20075-LPL	TT20075-ESD
2030 x 750	TT20375-HPL	TT20375-LPL	TT20375-ESD
2000 x 900	TT20090-HPL	TT20090-LPL	TT20090-ESD
2030 x 900	TT20390-HPL	TT20390-LPL	TT20390-ESD



**Laminated bench top -HPL**

- Light grey high pressure laminate
- Plastic edging
- Thickness 25 mm



**Laminated bench top -LPL**

- Light grey low pressure laminate
- Plastic edging
- Thickness 25 mm



**ESD**

- Light grey laminate surface
- Grey edging
- Thickness 25 mm
- Semi-conductive (ESD)

**The Concept Ergo bench can be equipped with castors!**



**Castor set Ø100 ESD** Code LCS100CE-ESD  
**Castor set Ø100** Code LCS100CE  
 Load capacity with castors 300 kg. Always adjust the bench with castors to the lowest position when the bench is moved.

**Spacer bar for Concept Ergo Allen key adjustable frames**

Name	Code
Spacer bar for Concept Ergo Allen key 1000	SBCE1000-49
Spacer bar for Concept Ergo Allen key 1200	SBCE1200-49
Spacer bar for Concept Ergo Allen key 1500	SBCE1500-49
Spacer bar for Concept Ergo Allen key 1800	SBCE1800-49
Spacer bar for Concept Ergo Allen key 2000	SBCE2000-49

We recommend using a spacer bar for a Allen key adjustable frame with castors. The spacer bar is not suitable for any accessories.



**Lower shelf for Concept Ergo**

Name	Size W x D mm	Max load kg	Code
Lower shelf for Concept Ergo 1000	828 x 600	60	LSCE1000-49
Lower shelf for Concept Ergo 1200	1028 x 600	60	LSCE1200-49
Lower shelf for Concept Ergo 1500	1328 x 600	60	LSCE1500-49
Lower shelf for Concept Ergo 1800	1634 x 600	60	LSCE1800-49
Lower shelf for Concept Ergo 2000	1828 x 600	60	LSCE2000-49

This steplessly height-adjustable shelf offers reliable support for tools, components, or storage bins. Supplied complete with shelf and brackets. Suitable only for 750 mm and 900 mm bench frames.



**Transport skate**

Name	Max load kg	Code	Code ESD
Transport skate	180	854 061-41	854 061-49

With a transport skate, one person can easily move benches. For long-distance moving, you will need two transport skates

Compatible with tables with a max depth of 750 mm.



**Battery set**

Name	Suitability	Code
Battery set	Electric adjustable Concept Ergo, Treston QuatreX, TED, PowerX series	BSC001

Capacity: 2.15 Ah / 52 Wh – supports approx. 55 height adjustments (400 mm per lift), enabling reliable operation throughout the workday. Includes mounting bracket with screws and a 200 mm connection cable for easy integration with the control box. Only available in the UK and EU countries.



**Depth adjustable accessory bar for Concept Ergo**

Name	Code
Depth adjustable accessory bar Concept Ergo 1000	DBCE1000-49
Depth adjustable accessory bar Concept Ergo 1200	DBCE1200-49
Depth adjustable accessory bar Concept Ergo 1500	DBCE1500-49
Depth adjustable accessory bar Concept Ergo 1800	DBCE1800-49
Depth adjustable accessory bar Concept Ergo 2000	DBCE2000-49

Depth adjustable accessory bars are used with footrests 860136-49 and 860196-49. Six adjustment holes in 50 mm steps. In 750/900 mm deep benches, the nearest hole is 41.5 mm from the front edge of the bench top.



**Footrest, bar**

Name	Size W x D mm	Height mm	Tilting	Code
Footrest, bar	550 x 350	90-280	5-30°	860 136-49
Footrest, bar with gas action	550 x 350	90-260	5-30°	860 196-49

Used with depth adjustable accessory bar for Concept Ergo.

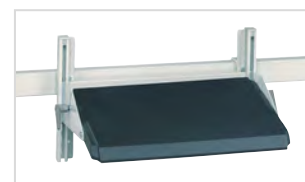

Footrest, bar



Footrest, bar, with gas action

# Concept hand crank workstation

- Select the bench frame size.
- Select a bench top to suit the frame: HPL laminate, LPL laminate or ESD bench top.



## Concept hand crank adjustable workbench frame

Size W x D mm	Max load kg	Code
1000 x 600	200	101 49 015
1000 x 750	200	101 49 030
1000 x 900	200	101 49 062
1200 x 600	200	101 49 016
1200 x 750	200	101 49 031
1200 x 900	200	101 49 063
1500 x 600	200	101 49 017
1500 x 750	200	101 49 032
1500 x 900	200	101 49 064
1800 x 600	200	101 49 018
1800 x 750	200	101 49 033
1800 x 900	200	101 49 065
Bench height steplessly adjustable		675 - 1025 mm

## Concept bench tops

Size W x D mm	Code HPL	Code LPL	Code ESD
1000 x 600	TT10060-HPL	TT10060-LPL	TT10060-ESD
1000 x 750	TT10075-HPL	TT10075-LPL	TT10075-ESD
1000 x 900	TT10090-HPL	TT10090-LPL	TT10090-ESD
1030 x 750	TT10375-HPL	TT10375-LPL	TT10375-ESD
1030 x 900	TT10390-HPL	TT10390-LPL	TT10390-ESD
1200 x 600	TT12060-HPL	TT12060-LPL	TT12060-ESD
1200 x 750	TT12075-HPL	TT12075-LPL	TT12075-ESD
1200 x 900	TT12090-HPL	TT12090-LPL	TT12090-ESD
1230 x 750	TT12375-HPL	TT12375-LPL	TT12375-ESD
1230 x 900	TT12390-HPL	TT12390-LPL	TT12390-ESD
1500 x 600	TT15060-HPL	TT15060-LPL	TT15060-ESD
1500 x 750	TT15075-HPL	TT15075-LPL	TT15075-ESD
1500 x 900	TT15090-HPL	TT15090-LPL	TT15090-ESD
1530 x 750	TT15375-HPL	TT15375-LPL	TT15375-ESD
1530 x 900	TT15390-HPL	TT15390-LPL	TT15390-ESD
1806 x 600	TT18060-HPL	TT18060-LPL	TT18060-ESD
1806 x 750	TT18075-HPL	TT18075-LPL	TT18075-ESD
1806 x 900	TT18090-HPL	TT18090-LPL	TT18090-ESD
1836 x 750	TT18375-HPL	TT18375-LPL	TT18375-ESD
1836 x 900	TT18390-HPL	TT18390-LPL	TT18390-ESD

## Depth adjustable accessory bar for Concept hand crank adjustable frame

Suitability	Depth adjustment mm	Code
Bench frame 1500 mm	150	860088-49
Bench frame 1800 mm	150	860089-49

The depth adjustable accessory bar can be used to fix a footrest or a CPU/printer holder

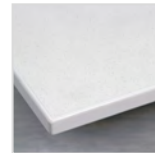

### Laminate bench top -HPL

- Light grey high pressure laminate
- Plastic edging
- Thickness 25 mm

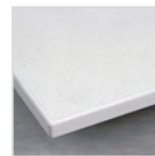

### Laminate bench top -LPL

- Light grey low pressure laminate
- Plastic edging
- Thickness 25 mm



### ESD bench top

- Light grey laminate surface
- Grey edging
- Thickness 25 mm
- Semi-conductive (ESD)

The Concept hand crank bench can be equipped with castors!



Castor set Ø100 ESD Code 860 429 -00

Castor set Ø100 Code 834 734 -00

Load capacity with castors 300 kg. Always adjust the bench with castors to the lowest position when the bench is moved.

# Concept Ergo and Concept upright tubes

Accessories are attached to the Concept Ergo and Concept hand crank bench with the aid of upright tubes or a complete, upright tube module. The module includes upright tubes, horizontal profile, and fixing plugs. The tubes or the module are attached to the rear case of the bench with the fixing plates that are delivered with the bench.

## Upright tubes

Name	Size W x D mm	Length (l) mm	Code
Upright tube	30 x 60	500	860 991-49
Upright tube	30 x 60	800	860 142-49
Upright tube	30 x 60	996	860 367-49
Upright tube	30 x 60	1359	860 024-49
Upright tube	30 x 60	1582	860 025-49
Horizontal profile	M500		HPM500-49
Horizontal profile	M750		HPM750-49
Horizontal profile	M900		HPM900-49
Horizontal profile	M1000		HPM1000-49
Horizontal profile	M1200		HPM1200-49
Horizontal profile	M1350		HPM1350-49
Horizontal profile	M1500		HPM1500-49
Horizontal profile	M1800		HPM1800-49
Horizontal profile	M2000		HPM2000-49
Fixing plug set (2 pcs)			FPSET

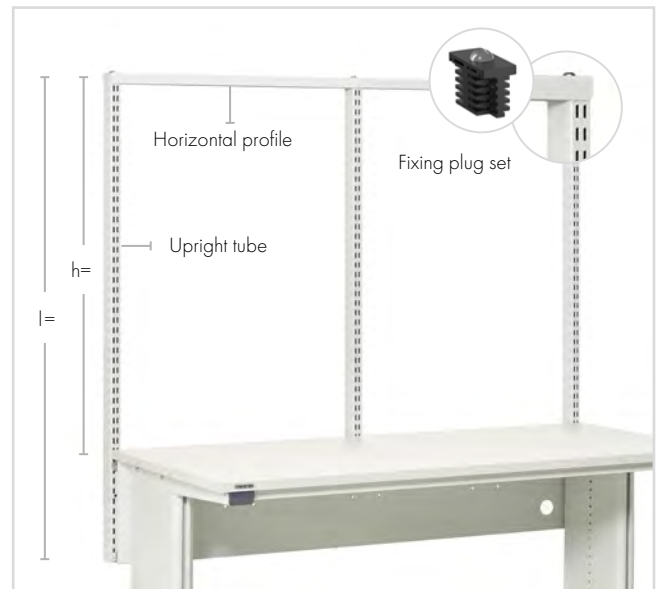

## Upright tube modules and compatibility

	Suitable for bench widths					Code S l=996 mm h=683 mm*	Code M l=1359 mm h=1046 mm*	Code L l=1582 mm h=1269 mm*
	CE = Concept Ergo, C = Concept	1000	1200	1500	1800			
1 x M750	CE/C	CE/C	CE/C	CE/C	CE/C	UTM1X750S-49	UTM1X750M-49	UTM1X750L-49
1 x M900	CE/C	CE/C	CE/C	CE/C	CE/C	UTM1X900S-49	UTM1X900M-49	UTM1X900L-49
1 x M1200		CE/C				-	UTM1X1200M-49	-
1 x M1500			CE/C	CE/C	CE/C	-	UTM1X1500M-49	-
1 x M1800				CE/C	CE/C	-	UTM1X1800M-49	-
2 x M500	CE/C	CE/C				UTM2X500S-49	UTM2X500M-49	UTM2X500L-49
2 x M750			CE/C	CE/C	CE/C	UTM2X750S-49	UTM2X750M-49	UTM2X750L-49
2 x M900				CE/C	CE/C	UTM2X900S-49	UTM2X900M-49	UTM2X900L-49
3 x M500			CE/C	CE/C		UTM3X500S-49	UTM3X500M-49	UTM3X500L-49
4 x M500					CE/C	UTM4X500S-49	UTM4X500M-49	UTM4X500L-49

\*h = module's height measured from Concept bench's top surface.

Load capacity 100 kg / module spacing.

Upright tube modules include 5 pcs of cable clips for easy cable management.

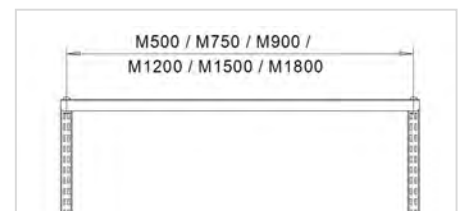

The modular (M) size refers to the distance between two upright tubes from the middle of the tube. The modular size is used to find the appropriate accessories.

The upright tubes can also be used separately without the horizontal profiles. In this case, please order the end cap 900370-00 for the upright tubes (1 pcs per upright tube).

## Upright tube fixing set for Concept Ergo for two uprights

Name	Code
Upright tube fixing set	UFSC-49

The upright tube fixing set enables flexible and secure attachment of two upright tubes to any position along the rear case of the Concept Ergo workbench—regardless of standard hole placements. The set includes brackets for two upright tubes. Load capacity is 100 kg per module. Upright tubes are sold separately.



# WB workbenches



See the ready-made configurations of the bench in our [3D Configurator!](#)

The WB workbench has been designed for use in demanding assembly environments. Besides offering modularity and great ergonomics, the bench is aesthetically pleasing.

Electric motor, manual hand crank or allen key height adjustment cater for standing or seated users, while the generous worktop depth and broad accessory range ensure that everything is within easy reach. Another feature of this design is the flush bench footprint; benches can be placed side-by-side, back-to-back, or right up against walls with no unnecessary gaps. You can design your workstation to fit your needs perfectly.

Worktop height can be adjusted between 700-1100 mm. The adjustment system in both cases utilises interlocking aluminium profiles, providing a strong, rigid frame. Steel frame parts are epoxy powder coated light grey paint. Worktops are of 25 mm laminated particle board, adjustable feet are provided for fine levelling.



300 kg



EPA

- Designed for the needs of R&D, electronics assembly and testing
- Ergonomic and easily adaptable to a large variety of tasks and environments
- Extensive range of accessories to meet any need
- Various layout possibilities from back-to-back to corner solutions

## ACCESSORIES ON PAGE 85

Extensive range of accessories available for ergonomic WB workstation.



Watch this [animation](#) showcasing the versatile usage options

# WB workbench examples



## 1. WB mobile industrial office workstation

Qty	Name	Code
1	WB electric adjustable bench 1100	WB811 EL
1	Castor set	LCS100
1	Upright profile	AL2X110W
1	LCD bracket	MH
1	Bin profile	BP100
1	Auxiliary steel shelf A5	ASSA5
2	Treston NaturLite Led Wing 500	TNL500W
1	Drawer unit 35/10	DU3510-49
1	Fastening set for drawer unit 35	855 061-49
1	Bottle holder	CH

## 2. WB packing workstation

Qty	Name	Code
1	WB electric adjustable bench 1500	WB815 EL
1	WB side worktop	WB804ST
1	Upright profile	AL2X150W
1	Support bracket	HSB150
1	Treston NaturLite Led 1200	TNL1200
1	Shelf ALH	ALH150
1	Divider hoops	PDH
1	Recycling material bin	PRMB
1	Power rail 331, 3 sockets + 2 x USB	TPR3-001
1	Drawer unit 35/10	DU3510-49
1	Fastening set for drawer unit 35	855 061-49
1	Lower shelf AT	AT150 WB

## 3. WB assembly workstation

Qty	Name	Code
1	WB electric adjustable bench 1800	WB818 EL
1	WB side worktop	WB804 ST
1	Upright profile	AL2X180W
1	Accessory frame AKK	AKK180
1	Support bracket	HSB180
1	Treston NaturLite Led 1200	TNL1200
1	Shelf ALH	ALH180
1	Power rail 683, 5 sockets + switch + 2 x USB	TPR7-001
1	Adjustable shelf ASH	ASH70
1	LCD swivel arm	MA
1	Swivel arm with tray	AKV400
1	Drawer unit 35/20	DU3520-49
1	Fastening set for drawer unit 35	855 061-49
2	Bin profile	BP100
1	Auxiliary steel shelf A4	ASSA4

## 4. WB ESD workstation

Qty	Name	Code ESD
1	WB electric adjustable bench 1800	WB818 EL ESD
1	Earthing box ESD	J6603
1	Upright profile	AL2X180W
1	Support bracket	HSB180
1	Treston NaturLite Led 1200	TNL1200
1	Shelf ALH ESD	ALH180 ESD
1	Accessory frame AKK ESD	AKK180
1	Perforated panel ESD	ARL70
2	Bin profile ESD	BP100 ESD
2	Auxiliary steel shelf A5	ASSA5
1	Swivel arm with tray ESD	AKV400 ESD
1	LCD swivel arm	MA
1	Drawer unit 35/20	DU3520-49
1	Fastening set for drawer unit 35	855 061-49
1	Magnifying lamp Wave LED ESD	TWL ESD

# Designing WB workbench

- Select the height adjustment method: allen key, electric or crank.
- Select a bench top to suit the frame: laminate or ESD bench top.

## WB allen key adjustable bench

Bench size W x D mm	Max load kg	Code	Code ESD
1073 x 800	300	WB811	WB811 ESD
1500 x 800	300	WB815	WB815 ESD
1800 x 800	300	WB818	WB818 ESD

We recommend using cable tidy WBCT with WB allen key adjustable benches.

## WB electric adjustable bench

Bench size W x D mm	Max load kg	Code	Code ESD
1073 x 800	300	WB811 EL	WB811 EL ESD
1500 x 800	300	WB815 EL	WB 815 EL ESD
1800 x 800	300	WB818 EL	WB818 EL ESD

Height adjustment speed 20 mm/ second.

Cable tidy as standard.

## WB crank adjustable bench

Bench size W x D mm	Max load kg	Code	Code ESD
1073 x 800	200	WB811 C	WB811 C ESD
1500 x 800	200	WB815 C	WB815 C ESD
1800 x 800	200	WB818 C	WB818 C ESD

Cable tidy as standard.



WB electric adjustable bench has a desk panel with memory function

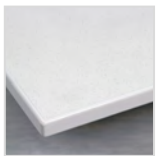

### Laminate bench top

- Light grey low pressure laminate
- Plastic edging
- Thickness 25 mm



### ESD bench top

- Light grey laminate surface
- Grey edging
- Thickness 25 mm
- Semi-conductive (ESD)

The WB bench can be equipped with castors!



Castor set Ø100 ESD Code LCS100 ESD

Castor set Ø100 Code LCS100

Load capacity with castors is the same as the bench loading capacity with adjustable screws. We recommend using the cable tidy WBCT with WB Allen-key adjustable benches. Always adjust the bench with castors to the lowest position when the bench is moved.

# WB extension benches



**+** **Accessories from page 85**  
Extensive range of accessories available for ergonomic WB workstation..



## 1. WB side worktop

This side worktop can be installed on either the right or left hand side of a WB bench to increase the surface area. Installation can be either at the same height, or lower than the main worktop with the brackets provided. Load capacity is 40 kg, and it is suitable for all WB models in the range.

Size W x D mm	Max load kg	Code	Code ESD
400 x 800	40	WB804 ST	WB804 ST ESD

## 2. WB corner worktop

A corner worktop can be used with two WB benches to create a 90° angle setup. This unit consists of a worktop and all necessary components. It requires no additional leg frames, simply mounting to the standard benches with the brackets provided. Load capacity for this worktop is 80 kg. Doesn't suit crank adjustable bench. Suitable for WB EL to order.

Size W x D mm	Max load kg	Code	Code ESD
1154 x 1154	80	WB1212 CT	WB1212 CT ESD

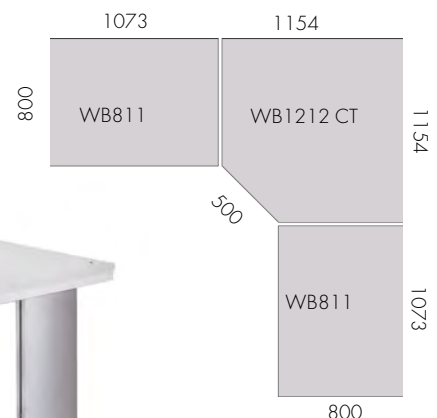

# Treston QuatreX workbenches



See the ready-made configurations of the bench in our [3D Configurator!](#)

Treston QuatreX electrical workbench is specifically designed to offer supreme stability, flexibility, and precision. With modern and ergonomic design combined with the highspeed electrical height adjustment this workbench is the ultimate choice for professionals who demand excellence in their work environments.

Treston QuatreX introduces the capability to utilize both perforated and aluminium uprights, offering modular flexibility in workstation setup. Whether in luxury goods manufacturing, electronics, fine mechanics, logistics, maintenance, or R&D labs, Treston QuatreX adapts seamlessly to diverse industry needs.

Treston QuatreX seamlessly merges the stability of a traditional four-legged workbench with the added advantage of height adjustment, ensuring minimal vibration for tasks requiring precision. Equipped with four powerful motors, it boasts the fastest adjusting speed we've ever designed for electric workbenches, allowing users to transition from down to up in less than 14 seconds.



300 kg



EPA

- Designed for professionals who demand excellence in their work environments.
- Extreme stability and less vibration.
- Flexibility and versatility – choose perforated or aluminium uprights.
- Speed of adjustment - from down to up in less than 14 seconds.

## ACCESSORIES ON PAGE 69 AND 85

Superior range of accessories available for ergonomic Treston QuatreX workstation.



Watch the feature showcase [video](#)

# Treston QuatreX workbench examples



## 1. Treston QuatreX assembly workstation

Qty	Name	Size mm	Code
1	QuatreX electric bench frame	1525 x 750	QX15375-41
1	Laminate bench top	1530 x 750	TT15375-LPL
1	Upright profiles	1489 x 1200	AL2X150QX
1	Accessory frame		AKK150
1	Support bracket	1500	HSB150
1	Treston NaturLite Led Plus	1200	TLN1200P
1	Side plate	depth 750	SPQX750-49
1	Shelf	1500 x 310	ALH150
2	Bin profile	685	BP70
4	Stacking bin	149 x 192 x 105	1520-1
3	Stacking bin	186 x 300 x 156	1930-1
1	Adjustable shelf	660 x 400	ASH70
1	Auxiliary steel shelf	217 x 330	ASSA4
1	Auxiliary steel shelf	159 x 210	ASSA5
1	Rotating tool panel frame	513 x 320	880 865-49P
1	Perforated panel	470 x 300	860 951-49
1	Equipment tray	500 x 250 x 125	928 49 002P
2	Arm adapter		890 525-49

## 2. Treston QuatreX packing workstation

Qty	Name	Size mm	Code
1	QuatreX electric bench frame	1525 x 750	QX15375-41
1	Laminate bench top	1530 x 750	TT15375-LPL
1	Upright tube module, 1359 mm	2 x M500	UTM2X500M-49
1	Recycling material bin		PRMBQX
1	Shelf for packing material	1167 x 600 x 32	SPM1200-49
1	Adjustable fastening set under worktop		SPMAF-49
1	Divider hoops set	400 x 280	PDH600-49
1	Side plate	depth 750	SPQX750-49
1	Printer platform slideable	315 x 530	859 060-49
1	LCD swivel arm		MA
1	Tablet bracket		MY
1	Perforated back panel	968 x 389	861 532-49
1	Tape roll storage rack for perforated panel	122 x 110 x 254	TRRP-49
2	Treston NaturLite Led Wing	500	TNL500W
1	Tiltable top shelf	967 x 300	TTSM10003-49
1	Bottle holder	Ø 100	859 063-49
1	Tool tray	1000 x 60	PTH100

## 3. Treston QuatreX maintenance workstation

Qty	Name	Size mm	Code
1	QuatreX electric bench frame	1525 x 750	QX15375-41
1	Laminate bench top	1530 x 750	TT15375-HPL
1	Upright tube module, 1359 mm	2 x M750	UTM2X750M-49
1	Light and balancer rail	2 x M750	91849006P
1	Treston NaturLite LED	1200	TNL1200
1	Perforated tool cabinet	720 x 255 x 900	852 629-49
1	Perforated back panel	718 x 1003	861 514-49
1	Drawer unit 45	450 x 520 x 260	604 49 001
1	Fastening set for drawer unit 45		855 058-49
1	Shelf for packing material	1167 x 600 x 32	SPM1200-49
1	Adjustable fastening set under worktop		SPMAF-49
1	Steel shelf	740 x 300	836 028-49
1	Recycling material bin		PRMBQX
1	Equipment tray	500 x 250 x 125	928 49 002P
5	Stacking bin	149 x 250 x 130	1525-6
1	Castor set	Ø100mm	LCS100

## 4. Treston QuatreX ESD workstation

Qty	Name	Size mm	Code ESD
1	QuatreX electric bench frame	1525 x 750	QX15375-41
1	ESD bench top	1530 x 750	TT15375-ESD
1	ESD grounding set		QX-ESD
1	Upright profiles	1489 x 1200	AL2X150QX
1	Accessory frame		AKK150
1	Support bracket	1500	HSB150
1	Shelf ESD	1500 x 310	ALH150 ESD
1	Treston NaturLite Led Plus	1200	TNL1200P
2	Perforated panel	668 x 500	ARL70
1	Small-parts storage cabinet	310 x 180 x 290	291-4ESD
1	Bracket for fixing small plastic storage cabinet to perforated panel		890 535-51
1	LCD swivel arm		MA
1	Power rail	683	TPR7-001
1	Swivel arm with tray	460 x 210	AKV400 ESD

# Designing Treston QuatreX workstation

- Select the bench frame and add ESD grounding set, if needed.
- Select a bench top to suit the frame: HPL laminate, LPL laminate or ESD bench top.
- Choose either perforated or aluminium uprights and equip with accessories.



## Treston QuatreX bench frame

Name	Size W x D mm	Max load kg	Code
Four-leg electric bench frame	1025 x 750	300	QX10375-41
Four-leg electric bench frame	1225 x 750	300	QX12375-41
Four-leg electric bench frame	1525 x 750	300	QX15375-41
Four-leg electric bench frame	1825 x 750	300	QX18375-41
Four-leg electric bench frame	2025 x 750	300	QX20375-41
Four-leg electric bench frame	1025 x 900	300	QX10390-41
Four-leg electric bench frame	1225 x 900	300	QX12390-41
Four-leg electric bench frame	1525 x 900	300	QX15390-41
Four-leg electric bench frame	1825 x 900	300	QX18390-41
Four-leg electric bench frame	2025 x 900	300	QX20390-41
ESD Grounding set for Treston QuatreX			QX-ESD
Height adjustment speed	36 mm / second		

## Treston QuatreX bench tops

Size W x D mm	Code HPL	Code LPL	Code ESD
1030 x 750	TT10375-HPL	TT10375-LPL	TT10375-ESD
1030 x 900	TT10390-HPL	TT10390-LPL	TT10390-ESD
1230 x 750	TT12375-HPL	TT12375-LPL	TT12375-ESD
1230 x 900	TT12390-HPL	TT12390-LPL	TT12390-ESD
1530 x 750	TT15375-HPL	TT15375-LPL	TT15375-ESD
1530 x 900	TT15390-HPL	TT15390-LPL	TT15390-ESD
1836 x 750	TT18375-HPL	TT18375-LPL	TT18375-ESD
1836 x 900	TT18390-HPL	TT18390-LPL	TT18390-ESD
2030 x 750	TT20375-HPL	TT20375-LPL	TT20375-ESD
2030 x 900	TT20390-HPL	TT20390-LPL	TT20390-ESD

**The QuatreX bench can be equipped with castors!**



**Castor set Ø100 ESD** Code LCS100  
**Castor set Ø100** Code LCS100 ESD

Load capacity with castors 300 kg. Always adjust the bench with castors to the lowest position when the bench is moved.

## Side plates

Name	Size mm	Code
Side plates for Treston QuatreX	depth 750	SPQX750-49
Side plates for Treston QuatreX	depth 900	SPQX900-49

The optional side plates, available as an accessory, ensure a safe environment when two tables are used side by side. Includes two plates, right hand and left hand versions.

## Battery set

Name	Suitability	Code
Battery set	Electric adjustable Concept Ergo, Treston QuatreX, TED, PowerX series	BSC001

Capacity: 2.15 Ah / 52 Wh – supports approx. 55 height adjustments (400 mm per lift), enabling reliable operation throughout the workday. Includes mounting bracket with screws and a 200 mm connection cable for easy integration with the control box. Only available in the UK and EU countries.

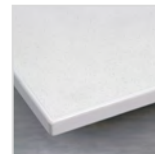

### Laminate bench top -HPL

- Light grey high pressure laminate
- Plastic edging
- Thickness 25 mm

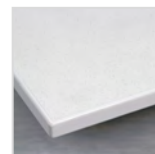

### Laminate bench top -LPL

- Light grey low pressure laminate
- Plastic edging
- Thickness 25 mm



### ESD bench top

- Light grey laminate surface
- Grey edging
- Thickness 25 mm
- Semi-conductive (ESD)



# Treston QuatreX uprights

QuatreX is the first Treston workbench to utilize both upright tubes, or upright tube modules, and aluminium upright profiles, offering more flexibility in workstation setup. The tubes or the module, and aluminium upright profiles are attached to the rear case of the bench.

+

**Accessories from page 69 and 85**

Treston QuatreX workbench gives you the option to select either steel or aluminum uprights.

### Aluminium upright profiles for Treston QuatreX

Suitable for bench widths	Size W x H mm	Code
1025*, 1225	1060 x 1200	AL2X110QX
1525	1489 x 1200	AL2X150QX
1825, 2025	1789 x 1200	AL2X180QX

Upright profiles are needed to attach aluminium accessories to the Treston QuatreX bench. Includes 2 vertical and 1 horizontal profile. With 3 cable clips (CC8). Load capacity 150 kg/AL2X.

\*used without a horizontal profile for 700 mm wide accessories (for example ASH70).



### Upright tubes

Name	Size W x D mm	Length (l) mm	Code
Upright tube	30 x 60	500	860 991-49
Upright tube	30 x 60	800	860 142-49
Upright tube	30 x 60	996	860 367-49
Upright tube	30 x 60	1359	860 024-49
Upright tube	30 x 60	1582	860 025-49
Horizontal profile	M500		HPM500-49
Horizontal profile	M750		HPM750-49
Horizontal profile	M900		HPM900-49
Horizontal profile	M1000		HPM1000-49
Horizontal profile	M1200		HPM1200-49
Horizontal profile	M1350		HPM1350-49
Horizontal profile	M1500		HPM1500-49
Horizontal profile	M1800		HPM1800-49
Horizontal profile	M2000		HPM2000-49
Fixing plug set (2 pcs)			FPSET

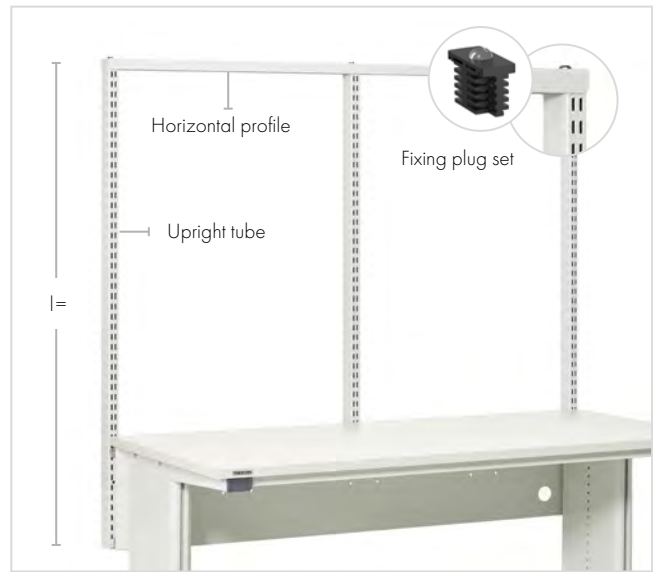

### Upright tube modules and compatibility

	Suitable for bench widths					Code S l=996 mm	Code M l=1359 mm	Code L l=1582 mm
	Q = QuatreX bench							
	1025	1225	1525	1825	2000			
1 x M1200		Q				-	UTM1X1200M-49	-
1 x M1500			Q			-	UTM1X1500M-49	-
1 x M1800				Q	Q	-	UTM1X1800M-49	-
2 x M500	Q					UTM2X500S-49	UTM2X500M-49	UTM2X500L-49
2 x M750			Q			UTM2X750S-49	UTM2X750M-49	UTM2X750L-49
2 x M900				Q	Q	UTM2X900S-49	UTM2X900M-49	UTM2X900L-49
3 x M500			Q			UTM3X500S-49	UTM3X500M-49	UTM3X500L-49
4 x M500					Q	UTM4X500S-49	UTM4X500M-49	UTM4X500L-49

Load capacity 150 kg.

The upright tube module includes upright tubes, horizontal profile, and fixing plugs. Includes 5 pcs of cable clips for easy cable management.

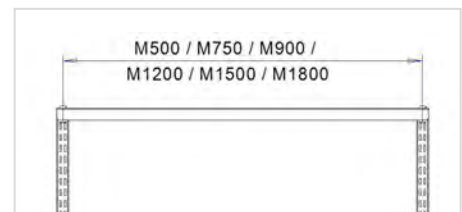

The modular (M) size refers to the distance between two upright tubes from the middle of the tube. The modular size is used to find the appropriate accessories.

# Electric Desk TED for industrial use



See the ready-made configurations of the bench in our [3D Configurator!](#)

Treston Electric Desk TED adjusts to different heights quickly and silently, extending from as low as 630 mm all the way up to 1270 mm. Accommodating a wide range of heights serves especially well in light-duty assembly work and packing applications, where the handled items can vary from big to small. TED is also very well-suited for control rooms and control desk needs, accommodating multiple screens and providing good ergonomics for 24/7 operations. A desk with a quick and wide adjustment range helps keep employees working comfortably and ergonomically in all situations.

The desk serves also in R&D laboratories as well as industrial offices well, as it withstands loads of 200 kg, and the desk can be customized with a range of accessories. The above- and below-desk accessories further enhance ergonomics, free desk space and provide order.



200 kg



EPA

- Quick, silent and wide height adjustment 630-1270 mm (range 64 cm)
- This ergonomic sit-stand desk perfectly suits light-duty assembly work, packing applications, R&D and industrial offices.

## ACCESSORIES ON PAGE 69

Comprehensive range of accessories available for ergonomic TED workstation



Watch the 2 min [animation](#) showcasing the features

# TED desk examples



## 1. TED industrial office desk

Qty	Name	Size mm	Code
1	Treston Electric Desk	1500 x 800	TED815-41
1	Upright Tube Pair with a flange	400	TTP400-49
2	Treston Display Bracket for light duty		TDB-49
1	Drawer unit 35/20	353 x 470 x 202	DU3520-49
1	Fastening set for drawer unit 35		855 057-49
1	Bottle holder ESD for upright tube	Ø100	859 063-49

## 2. TED industrial office desk

Qty	Name	Size mm	Code
1	Treston Electric Desk	1100 x 800	TED811-41
1	Upright Tube Pair with a flange	790	TTP790-49
1	Perforated back panel	M900	861 516-49
1	LCD monitor holder for perforated panel		890 715-49
2	Treston NaturLite LED Wing 500		TNL500W
2	Auxiliary steel shelf for perforated panel	159 x 210	ASSA5PP
1	Bottle holder ESD for upright tube	Ø100	859 063-49
1	Laptop/printer shelf ESD	365 x 365	930 49 001P
1	Cable clip set for upright tubes		CC5
1	Power rail	836	TPR9-010

## 3. TED ESD workstation

Qty	Name	Size mm	Code ESD
1	Treston Electric Desk ESD	1500 x 800	TED815-49
1	Upright Tube Pair with a flange	790	TTP790-49
1	Light and balancer rail ESD		918 49 011P
1	Treston IntoLite LED	850	TIL850
1	Perforated back panel	M1350	861 521-49
1	Treston Display Bracket for light duty		TDB-49
1	Curved bin rail ESD with arm	770 x 54	929 49 002P
1	Steel shelf ESD M1350	1340 x 300	860 787-49
1	Aluminium bin rail M1350		BP1350C
2	Auxiliary steel shelf	159 x 210	ASSA5
1	Magnifying lamp Wave LED ESD		TWL ESD
1	Drawer unit 35/10	353 x 470 x 102	DU3510-49
1	Fastening set for drawer unit 35		855 057-49
1	Power rail	836	TPR9-010

## 4. TED packing station

Qty	Name	Size mm	Code
1	Treston Electric Desk	1800 x 800	TED818-41
1	Upright Tube Pair with a flange	790	TTP790-49
1	Paper roll holder set for upright tube		859 041-49P
1	Pair of paper roll dividers		RD25
1	Cutter	1350	PPC135
1	Steel shelf ESD M1500	1490 x 300	890 756-49
3	Divider pair	285 x 190	010 004-49
1	Light and balancer rail ESD		918 49 006P
1	Treston NaturLite LED	1180	TNL1200
1	Rotating tool frame ESD, double arm	513 x 320	880 865-49P
1	Perforated panel ESD	470 x 300	860 951-49
1	Recycling material bin		PRMB
1	Tool holder box		PPH TXL

# Designing TED desk

- TED desk consists of the frame and the bench top.
- Equip with accessories. To equip TED with above-desk accessories, select first the upright tube pair.

## TED Electric Desk

Size W x D mm	Module	Max load kg	Code	Code ESD
900 x 800	M750	200	TED809-41	TED809-49
1100 x 800	M900	200	TED811-41	TED811-49
1500 x 800	M1350	200	TED815-41	TED815-49
1800 x 800	M1500	200	TED818-41	TED818-49

Height adjustment speed 22 mm / second

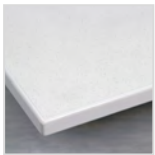

### Laminate bench top

- 25 mm low pressure laminate
- light grey surface
- Plastic edging



### ESD bench top

- light grey laminate surface
- Grey edging
- Thickness 25 mm
- Semi-conductive (ESD)



## Upright Tube Pair with a flange

Size W x D x H mm	Code ESD
70 x 100 x 418	TTP400-49
70 x 100 x 793	TTP790-49
70 x 100 x 997	TTP990-49

Treston upright tubes enable TED electric desk to be accessorised in many ways. Fitted on worktop with screws.



### Accessories from page 69

Wide range of accessories available for Treston Electric Desk TED.



Upright Tube Pair with a flange

**Lower shelf for TED desk**

Size W x D mm	Suitable for	Max load kg	Code
465 x 400	All TED benches	60	LST500-49
715 x 400	TED811, TED,815, TED818	60	LST750-49
865 x 400	TED815, TED818	60	LST900-49
965 x 400	TED815, TED818	60	LST1000-49
1165 x 400	TED818	60	LST1200-49
1315 x 400	TED818	60	LST1350-49
Divider hoops set (4 pcs) 400 x 400			PDH400-49

400 mm deep lower shelf for many purposes. Includes back lip. Fitted under worktop with screws. The lower shelf can also be equipped with divider hoops.



**Battery set**

Name	Suitability	Code
Battery set	Electric adjustable Concept Ergo, Treston QuatreX, TED, PowerX series	BSC001

Capacity: 2.15 Ah / 52 Wh – supports approx. 55 height adjustments (400 mm per lift), enabling reliable operation throughout the workday. Includes mounting bracket with screws and a 200 mm connection cable for easy integration with the control box. Only available in the UK and EU countries.



The TED desk can be equipped with castors!

**Castor set Ø100 ESD** Code LCS100 ESD

**Castor set Ø100** Code LCS100

Always adjust the bench with castors to the lowest position when the bench is moved.

# Treston PowerX workstations



Watch [Treston PowerX Series showcase video](#)

**Work efficiently anywhere within the facility, without being tied to a fixed power outlet.** The Treston PowerX powered mobile workstation series is designed for flexible working in industrial, logistics, laboratory, and ESD-protected environments.

When equipped with a power station, PowerX workstations enable continuous operation of computers, printers, bar-code scanners, and other essential equipment. This makes them ideal for dynamic workflows where tasks, layouts, or locations frequently change.

With multiple models available, the PowerX series can be tailored to different applications, load requirements, and ergonomic needs. Electric height adjustment, mobility, and a wide range of accessories support efficient, adaptable, and ergonomically sound working throughout the facility.



50-300 kg



EPA

- **Treston PowerX Move:** A lightweight, mobile, powered workstation with rounded corners, ideal for tasks requiring continuous movement.
- **Treston PowerX TED:** A versatile powered mobile workstation offering increased work surface and flexibility for mixed tasks and equipment setups.
- **Treston PowerX QuatreX:** A powered, mobile workbench designed especially for precision-demanding tasks, including electronics assembly.



Watch [PowerX Move feature showcase video](#)

# Treston PowerX Move

- Treston PowerX Move is a versatile mobile, electric height-adjustable workstation.
- Designed for light-duty applications.
- Two versions available: for a power station or a battery set.
- Includes four swivel castors (Ø100 mm), two with brakes.
- A dedicated range of accessories is available for the Treston PowerX Move workstation (see page 47).

## 1. Treston PowerX Move workstation (for power station TPXPS)

Size W x D mm	Max load kg	Code	Code ESD
800 x 600	50	TPXMO8060-41	TPXMO8060-49

When combined with the Power Station TPXPS, Treston PowerX Move enables users to perform tasks flexibly anywhere within the facility, eliminating the need to be near a fixed power outlet. Includes magnetic cable management chain (length approx. 135 cm) and shelf for power station. The workstation includes also a power cable, length 320 cm. The PowerX power station (TPXPS) is ordered separately.

Height adjustment speed 22 mm / second

## 2. Treston PowerX Move workstation (for battery set BSC001)

Size W x D mm	Max load kg	Code	Code ESD
800 x 600	50	TPXMO8060L-41	TPXMO8060L-49

When combined with the battery set BSC001, Treston PowerX Move enables users to adjust the table height and perform tasks ergonomically anywhere within the facility. The workstation includes a power cable, length 320 cm. The battery set BSC001 is ordered separately.

Height adjustment speed 22 mm / second



**+** **Accessories from page 47**  
A dedicated range of accessories is available for the Treston PowerX Move workstation.

# Treston PowerX TED

- Includes TED bench, castor set, cable tidy and CPU-holder for power station.
- To accessorize, start with the upright tube pair with a flange and equip with accessories suitable for module M750.

## Treston PowerX TED workstation (for power station TPXPS)

Size W x D mm	Max load kg	Code	Code ESD
900 x 800	200	TPXTED809-41	TPXTED809-49

When combined with the Power Station TPXPS, Treston PowerX TED enables users to perform tasks flexibly anywhere within the facility, eliminating the need to be near a fixed power outlet. The PowerX power station (TPXPS) is ordered separately.

Height adjustment speed 22 mm / second



# Treston PowerX QuatreX

- Includes QuatreX bench frame, bench top, castor set, CPU holder for power station and grounding set (with ESD version).
- Choose either perforated upright tubes (module M1000) or aluminium uprights (AL2X110QX without horizontal profile).
- With upright tubes, use accessories suitable for module M1000. With aluminium uprights, use 700 mm wide accessories (for example ASH70).

## Treston PowerX QuatreX workstation (for power station TPXPS)

Size W x D mm	Max load kg	Code	Code ESD
1030 x 750	300	TPXQX10375-41	TPXQX10375-49

When combined with the Power Station TPXPS, Treston PowerX QuatreX enables users to perform tasks flexibly anywhere within the facility, eliminating the need to be near a fixed power outlet. The PowerX power station (TPXPS) is ordered separately.

Height adjustment speed 36 mm / second



**Accessories from page 69**  
A comprehensive range of accessories is available for the Treston PowerX TED workstation.



**Accessories from page 69 and 85**  
An extensive range of accessories is available for the Treston PowerX QuatreX workstation.



**Treston PowerX power station**

Name	Size W x D x H mm	Suitability	Code
Treston PowerX power station	398 x 200 x 284	Treston PowerX Move Treston PowerX TED Treston PowerX QuatreX	TPXPS-UK

1024 Wh capacity, charging takes only 1 h. Enough battery power for an 8-hour shift. Multiple power outputs support simultaneous use of computers, displays, and measurement devices.

Only available in the UK.



**Battery set**

Name	Suitability	Code
Battery set	Electric adjustable Concept Ergo, Treston QuatreX, TED, PowerX series	BSC001

Capacity: 2.15 Ah / 52 Wh – supports approx. 55 height adjustments (400 mm per lift), enabling reliable operation throughout the workday. Incl. mounting bracket with screws and a 200 mm connection cable for easy integration with the control box. Only available in the UK and EU countries.



# Accessories for Treston PowerX Move

**Aluminium profile for Treston PowerX Move**

Name	Height mm	Max load kg	Code
Aluminium profile for PowerX Move	500	15	AL2XMO

The profile is intended for use with the MH LCD screen holder or the TCH thin client PC holder.



**Holder for Thin Client PC**

Name	Size W x D x H mm	Max load kg	Code
Holder for Thin Client PC	250 x 45-65 x 145	5	TCH

**LCD bracket MH**

Name	Max load kg	Code
LCD bracket MH	15	MH

The quick-release mechanism is equipped with the standard used flat-screen mount 75 x 75 and 100 x 100 for the mounting of all normal flat-screens.

Aluminium profile for Treston PowerX Move, Holder for Thin Client PC and LCD bracket MH



**Lower shelf for Treston PowerX Move**

Name	Size W x D mm	Max load kg	Code
Lower shelf for PowerX Move	775 x 535	20	LSMO-49



**Accessory box with ESD shelf bin 4020-4ESD**

Name	Size W x D x H mm	Code
Accessory box with ESD shelf bin	193 x 370 x 107	AB4020-4ESD



**Cable tidy for Treston PowerX Move**

Name	Size W x D x H mm	Code
Cable tidy for PowerX Move	600 x 60 x 100/40	TCTMO-49

The cable tidy is intended to be used together with the TPR3-001 power rail.

**Keyboard tray NT**

Size W x D x H mm	Code
525 x 399 x 133 (outer), 500 x 250 x 110 (inner)	NT 500 ESD



# Treston Quick Edge workstation



The easier the workstation's height adjustment gets, the more likely you will adjust it. Meet the industrial workstation with the quickest height adjustment on the market. Workstation height is adjusted with a completely new, innovative, and user-friendly mechanism. The patent pending height adjustment solution minimises the height exchange time between handled items and makes daily work more fluent, efficient, and ergonomic.

This industrial workstation is designed, for example, for packing and logistic centres, where the desk height adjustment is done according to the differently sized cartons. The Treston Quick Edge Workstation adapts for operators of different standing heights and increases both performance and ergonomics.



100 kg

- Extremely wide height adjustment range 570–1300 mm
- Patent pending solution: Adjust the optimal height effortlessly for every task / produced item

## ACCESSORIES ON PAGE 69

Comprehensive range of accessories available for Treston Quick Edge workstation



Watch the 2 min [video](#) showcasing the features

# Designing Quick Edge workstation

- Quick Edge workstation consists of the frame, the bench top and upright profiles.
- Equip with M1200 wide accessories, swivel arms or printer platforms.
- Quick Edge workstation can be used in EPAs with grounding set TQE-ESD.

## Quick Edge workstation

Size W x D mm	Module	Max load kg	Code
1200 x 700	M1200	100*	TQEW712-41

Static load capacity for bench top 100 kg, total load capacity for frame 300 kg.



The new, innovative, patent pending height adjustment solution minimises the height exchange time between handled items and makes daily work more fluent, efficient, and ergonomic. Bench top is adjusted without load due to the constant force springs as an adjustment mechanism.

## Grounding set for Treston Quick Edge workstation

Name	Code
Grounding set for Treston Quick Edge workstation	TQE-ESD

With this grounding set you can use Treston Quick Edge workstation in EPAs.



Grounding set for Treston Quick Edge workstation

## Spring set for Treston Quick Edge Workstation

Name	Code
Spring set for Treston Quick Edge Workstation	TQES

Replace the constant force spring set at least after every 10 000 operating cycles.



Quick Edge workstation can be equipped with castors.

Castor set Ø100 Code LCS100  
 Castor set ESD Ø 100 Code LCS100 ESD

# TP workbenches



See the ready-made configurations of the bench in our [3D Configurator](#)!

**TP workbench is a solid, standard industrial workbench that is suitable for various industrial tasks and environments**, such as testing, packing, repairing, inspecting. A cost-effective alternative that is also easy to customise using the wide range of accessories and add-ons.

This modular system enables high quality working environment. Customise your workstation to your own requirements.

## Stepless height adjustment

The height of workbenches in our TP range can be steplessly adjusted from 650 to 900 mm, which makes these benches suitable for work while sitting or standing. Packing is a typical example of work where the workbench height must be set correctly for the height of the user.



300 kg



EPA

- Standard and cost-effective workbench
- Suitable for a wide range of tasks and environments
- Superior range of accessories, easily reconfigured
- Steel frame with loading capacity up to 300 kg

## ACCESSORIES ON PAGE 69

Superior range of accessories available for ergonomic TP workstation



Watch this [animation](#) showcasing the versatile usage options

# TP workbench examples



1



2



3

## 1. TP workstation

Qty	Name	Size mm	Code
1	TP workbench	1200 x 700	TP712
1	Accessory frame	1200	TPK12-49
1	Upright tube module	M1200/1359	UTM1X1200M
1	Tilttable top shelf	M1200 x 300	TTSM12003-49
1	Light and balancer rail	M1200	918 49 010P
1	Treston Intolite LED	850	TIL850

## 2. TP repair workstation

Qty	Name	Size mm	Code
1	TP workbench	1500 x 700	TP715
1	Accessory frame	1500	TPK15-49
1	Upright tube module	2 x M750/1582	UTM2X750L-49
1	Light/balancer rail	2 x M750/1500	918 49 006P
1	Treston NaturLite	1200	TNL1200
1	Tilttable top shelf	M750 x 300	TTSM7503-49
2	Accessory box	220 x 300	ABTTS3-41
1	Lower shelf	1380 x 500	AT 150TPH
1	Perforated back panel	M750 x 1003	861 514-07
2	Aluminium bin rail	M750	BP750C
8	Stacking bin	149 x 192 x 105	1520-5/6
1	Perforated tool cabinet	M750 x 255 x 900	852 629-07
1	Drawer unit 45/14-1	450 x 520 x 140	603 49 001
1	Power rail	468	TPR4-001

## 3. TP packing workstation

Qty	Name	Size mm	Code
1	TP workbench	1800 x 700	TP718
1	Accessory frame	1800	TPK18-49
1	Upright tube module	2 x M900/1582	UTM2X900L-49
1	Light/balancer rail	2 x M900/1800	918 49 008P
1	Treston NaturLite	1200	TNL1200
1	LCD screen holder		930 49 002P
1	Equipment tray	500 x 250 x 125	928 49 002P
1	Perforated back panel	M900 x 389	861 516-49
1	Recycling material bin	530 x 280 x 585	PRMB
1	Roll holder set	M900	890 548-49P
1	Tilttable top shelf	M900 x 300	TTSM9003-49
1	Divider hoops set	300 x 400	PDH300-49
1	Aluminium bin rail	M900	BP900C
2	Auxiliary steel shelf	159 x 210	ASSA5
1	Auxiliary steel shelf	217 x 330	ASSA4
1	Pull-out steel shelf for printer	500 x 510 x 515	PSP50
1	Shelf for packing material	M900 x 600	SPM900-49
1	Adjustable fastening set under worktop		SPMAF-49
1	Divider hoops set SPM-shelf	400 x 280	PDH600
1	Power rail		TPR9-001

See options for rotating tool panel with perforated panel and other accessories on page 76.



**Castor set Ø100**, code 834 734 -00  
**Castor set Ø100 ESD**, code 860 429 -00  
**Insert set** (required to fit castors), code 853 289-00

**Load capacity with castors 150 kg.** We recommend using the accessory frame with the castors. Always adjust the bench with castors to the lowest position when the bench is moved.

# Designing TP workstation

- Select laminate or ESD version of the bench
- Equip with accessories. To equip TP with above-desk accessories, select first the upright tubes.



## TP workbench

Bench size W x D mm	Max load kg	Code	Code ESD
700 x 500	150	TP507	TP507 ESD
1000 x 500	150	TP510	TP510 ESD
1500 x 500	150	TP515	TP515 ESD
1000 x 700	300	TP710	TP710 ESD
1200 x 700	300	TP712	TP712 ESD
1500 x 700	300	TP715	TP715 ESD
1800 x 700	300	TP718	TP718 ESD
1500 x 900	300	TP915	TP915 ESD
1800 x 900	300	TP918	TP918 ESD

### 1. Lower shelf for TP

Name	Size W x D mm	Max load kg	Code
Lower shelf	1080 x 500	50	AT 120TPH
Lower shelf	1380 x 500	50	AT 150TPH
Lower shelf	1680 x 500	50	AT 180TPH

Not enough space above the workstation? Then utilise the space below. The lower shelf for TP bench simply hangs on the horizontal bars.

### 2. Lower steel shelf LSS

Name	Size W x D mm	Max load kg	Code
Lower shelf	1418 x 460	30	LSS150
Lower shelf	1718 x 460	30	LSS180
Low M-divider hoops (4 pcs/set)	460 x 315		LDH

Hangs on the horizontal bars. Can be equipped with steplessly adjustable low M-divider hoops.

### 3. Side worktop

Name	Size W x D mm	Max load kg	Code
Side worktop	400 x 700	35	TP704 ST
Side worktop	400 x 900	35	TP904 ST

Easy to fix to the legs of the bench. Can be fixed on the left or right side of the bench and brackets placed either above or underneath. Height adjustable 575-900 mm from the floor.

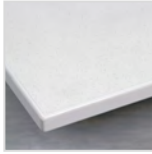

**Laminate bench top**

- 25 mm low pressure laminate
- Light grey surface
- Plastic edging



**ESD bench top**

- Light grey laminate surface
- Grey edging
- Thickness 25 mm
- Semi-conductive (ESD)



# TP extension benches

## Line extension TP-L

Each standard TP bench may also be supplied as a line extension. Fitted to the side of the main bench.

Bench size W x D mm	Max load kg	Code	Code ESD
1000 x 700	150	TP710 L	TP710 L ESD
1200 x 700	150	TP712 L	TP712 L ESD
1500 x 700	150	TP715 L	TP715 L ESD
1800 x 700	150	TP718 L	TP718 L ESD
1500 x 900	150	TP915 L	TP915 L ESD
1800 x 900	150	TP918 L	TP918 L ESD



## Angle extension TP-K

Each standard TP bench may also be supplied as an angle extension. Fitted to front angle of main bench.

Bench size W x D mm	Max load kg	Code	Code ESD
1000 x 500	150	TP510 K	TP510 K ESD
1200 x 700	150	TP712 K	TP712 K ESD



## Corner workbench TP-KK

A corner workbench can be used with two TP benches (with one H-frame pair) to create a 90 ° angle setup. TP KK unit consists of a worktop, two H-frames and a leg in the middle. Front side 565 mm.

Bench size W x D mm	Max load kg	Code	Code ESD
1100 x 1100	150	TP707 KK	TP707 KK ESD
1300 x 1300	150	TP909 KK	TP909 KK ESD



\* Workbench with one H-frame pair.

## SAP trolley

TP bench style construction. Height adjustment with allen key between 650-900 mm. Swivel castors (Ø 100 mm), two of which have brakes. Load capacity 150 kg. Lower shelf, extra shelf and push handle available separately.

Name	Size W x D mm	Max load kg	Code	Code ESD
Trolley	700 x 500	150	SAP507	SAP507 ESD
Trolley	1000 x 700	150	SAP710	SAP710 ESD
Lower shelf	700 x 500	40	AT507	AT507 ESD
Lower shelf	1000 x 700	40	AT710	AT710 ESD
Extra shelf	700 x 500	40	LT507	LT507 ESD
Extra shelf	1000 x 700	40	LT710	LT710 ESD
Handle	depth 500		PUSH50	PUSH50
Handle	depth 700		PUSH70	PUSH70



SAP trolley with AT lower shelf, LT extra shelf and PUSH handle

# TP upright tubes

Accessories are attached to the TP bench with the aid of upright tubes or a complete, upright tube module.

The module includes upright tubes, horizontal profile, and fixing plugs. The upright tubes or the upright tube module are attached to the back of the TP bench with accessory frame (ordered separately), which also includes the fixing plates for the upright tubes. When using three upright tubes with the bench, we recommend using the complete upright tube modules.

**+** **Accessories from page 69**  
Superior range of accessories available for ergonomic TP workstation.

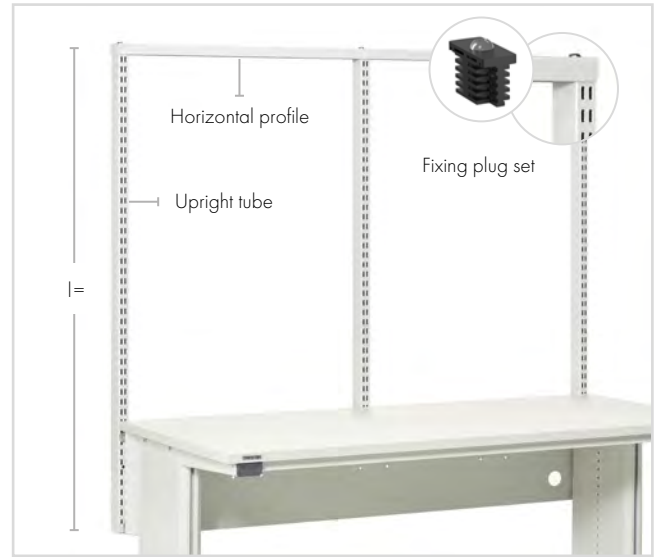

### Accessory frame

Bench frame width mm	Fixing points for uprights	Code
1000	1 x M900, 1 x M1000	TPK10-49
1200	1 x M750, 1 x M900, 1 x M1200	TPK12-49
1500	1 x M1500, 2 x M750	TPK15-49
1800	1 x M1800, 2 x M900	TPK18-49

Upright tubes or the upright tube module are always attached to TP bench with accessory frame. The accessory frame cannot be used on line or corner extensions.



Accessory frame

### Upright tubes

Name	Size W x D mm	Length (l) mm	Code
Upright tube	30 x 60	500	860 991-49
Upright tube	30 x 60	800	860 142-49
Upright tube	30 x 60	996	860 367-49
Upright tube	30 x 60	1359	860 024-49
Upright tube	30 x 60	1582	860 025-49
Horizontal profile	M500		HPM500-49
Horizontal profile	M750		HPM750-49
Horizontal profile	M900		HPM900-49
Horizontal profile	M1000		HPM1000-49
Horizontal profile	M1200		HPM1200-49
Horizontal profile	M1350		HPM1350-49
Horizontal profile	M1500		HPM1500-49
Horizontal profile	M1800		HPM1800-49
Horizontal profile	M2000		HPM2000-49
Fixing plug set (2 pcs)			FPSET

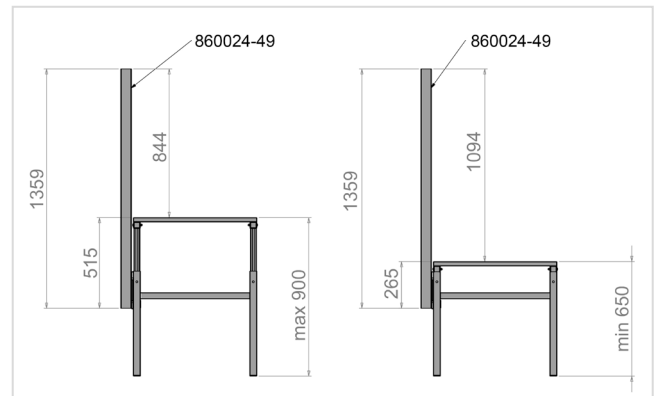

Usable height of the upright tube

### Aluminium bracket

Name	Code
Aluminium bracket	846 554-00

Bracket can be used to attached a single tube to the bench.



Upright tube with aluminium bracket attached to the bench

**Upright tube modules and compatibility**

	Suitable for bench widths TP = TP bench				Code S	Code M	Code L
	1000	1200	1500	1800	l=996 mm	l=1359 mm	l=1582 mm
1 x M750		TP			UTM1X750S-49	UTM1X750M-49	UTM1X750L-49
1 x M900	TP	TP			UTM1X900S-49	UTM1X900M-49	UTM1X900L-49
1 x M1200		TP			-	UTM1X1200M-49	-
1 x M1500			TP		-	UTM1X1500M-49	-
1 x M1800				TP	-	UTM1X1800M-49	-
2 x M500					UTM2X500S-49	UTM2X500M-49	UTM2X500L-49
2 x M750			TP		UTM2X750S-49	UTM2X750M-49	UTM2X750L-49
2 x M900				TP	UTM2X900S-49	UTM2X900M-49	UTM2X900L-49
3 x M500					UTM3X500S-49	UTM3X500M-49	UTM3X500L-49
4 x M500					UTM4X500S-49	UTM4X500M-49	UTM4X500L-49

Load capacity 100 kg / module spacing.

Upright tube modules include 5 pcs of cable clips for easy cable management.



The upright tubes or the upright tube module are attached to the back of the TP bench with accessory frame

# TP upright frame with bench top

TP upright frame with bench top is a lighter version of the TP workbench. In addition to the bench top attached to the frame, it can be equipped with any of the Concept accessories. It is ideal for lighter use, when some additional workspace is needed.

**TP upright frame**

Size W x H mm	Max load kg	Code
M750 x 1500	300	123 49 005
M750 x 1850	300	123 49 006
M900 x 1500	300	123 49 007
M900 x 1850	300	123 49 008

**Bench top & brackets for TP upright frame**

Size W x D mm	Max load kg	Code HPL	Code LPL	Code ESD
1200 x 600	60	TT12060-HPL	TT12060-LPL	TT12060-ESD
Corner bracket pair		860 139-49		

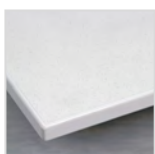
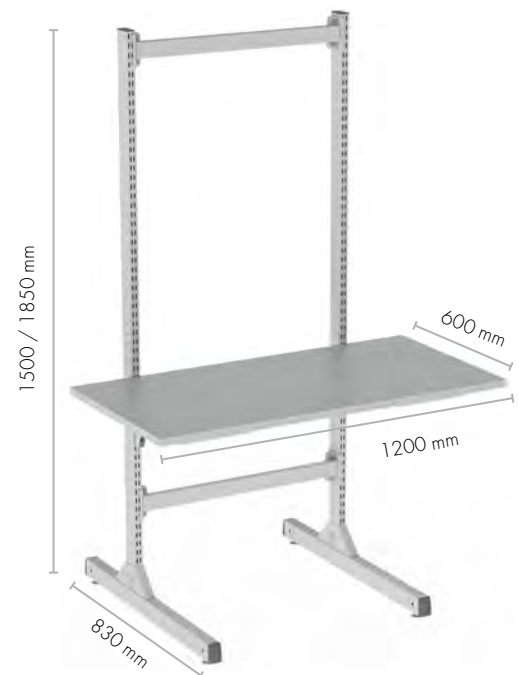

**Laminate bench top -HPL**

- Light grey high pressure laminate
- Plastic edging
- Thickness 25 mm

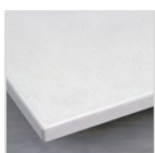

**Laminate bench top -LPL**

- Light grey low pressure laminate
- Plastic edging
- Thickness 25 mm



**ESD bench top**

- Light grey laminate surface
- Grey edging
- Thickness 25 mm
- Semi-conductive (ESD)

# TPH workbenches



See the ready-made configurations of the bench in our [3D Configurator!](#)

**The TPH workbench includes a pair of uprights and one shelf; composing one of our best selling workstations.** It has its own range of accessories, also in stock, and covering the essential, basic needs of any professional workstation.

## Stepless height adjustment

The height of TPH workbenches can be steplessly adjusted with allen-key from 650 to 900 mm, which makes these benches suitable for work while sitting or standing. The height adjustment of the laminate shelf is between 1080-1550 mm. Load capacity for the bench top is 300 kg and for the shelf 50 kg even load.



300 kg



EPA

- Standard and cost-effective workbench with one shelf
- Suitable for a wide range of tasks and environments
- Essential range of accessories for basic needs
- Steel frame with loading capacity up to 300 kg

## ACCESSORIES ON PAGE 90

Essential range of accessories available for ergonomic TPH workstation.

# TPH workbench examples



## 1. TPH workbench

Qty	Name	Size mm	Code
1	TPH workbench	1500 x 700	TPH715
1	Lower steel shelf	1418 x 460	LSS150
1	Divider hoop set	460 x 315	LDH

## 2. TPH workstation

Qty	Name	Size mm	Code
1	TPH workbench	1200 x 700	TPH712
1	Tool and lighting support	1200 x 600	KT120
1	Treston IntoLite LED	850	TIL850
1	Perforated panel	1115 x 750	RL120
1	Connector set		RK1

## 3. TPH ESD workstation

Qty	Name	Size mm	Code ESD
1	TPH workbench ESD	1800 x 700	TPH718 ESD
1	Tool and lighting support	1800 x 600	KT180
1	Treston NaturLite Led	1200	TNL1200
1	Perforated panel	1715 x 750	RL180
1	Connector set		RK1
3	Auxiliary steel shelf for perforated panel	159 x 243 x 56	ASSA5PP
2	Hook R46		839 086-51
1	Hook R42		838357-51
3	Stacking bin		1525-4ESD
1	LCD monitor holder for perforated panel		890 715-49
2	Swivel arm with tray ESD	460 x 210	CKV400 ESD
1	Component rack ESD	455 x 200 x 290	EPL12 ESD
18	Stacking bin	105 x 165 x 75	1015-4ESD
1	CPU holder ESD	180-225 x 450x50	854 440-49
1	Magnifying lamp Wave LED ESD		TWL ESD
1	Drawer unit 45/26-1	450 x 520 x 260	604 49 001

## 4. TPH workstation

Qty	Name	Size mm	Code
1	TPH workbench	1800 x 700	TPH718
1	Tool and lighting support	1800 x 600	KT180
1	Treston IntoLite LED	850	TIL850
2	Aluminium bin profile	1705	BP180
1	Metal shelf	1719 x 145	TH180
1	Tool holder box	400 x 300 x 150	PPH TXL
3	Auxiliary steel shelf	217 x 330	ASSA4
6	Stacking bin	149 x 192 x 105	1520-5
6	Stacking bin	149 x 250 x 130	1525-5
8	Stacking bin	105 x 165 x 75	1015-5
1	Power rail	1700	TPR17-001
1	Side worktop	400 x 700	TP704ST

# Designing TPH workstation

- TPH workbench comes with one shelf and a pair of uprights
- Select model either with ESD or laminate bench top
- Equip with accessories.

## Workbench TPH

Bench size W x D mm	Shelf size W x D mm	Max load kg	Code	Code ESD
1200 x 700	1200 x 310	300	TPH712	TPH712 ESD
1500 x 700	1500 x 310	300	TPH715	TPH715 ESD
1800 x 700	1800 x 310	300	TPH718	TPH718 ESD
1500 x 900	1500 x 310	300	TPH915	TPH915 ESD
1800 x 900	1800 x 310	300	TPH918	TPH918 ESD

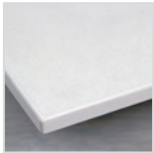

### Laminate bench top

- 25 mm low pressure laminate
- Light grey surface
- Plastic edging



### ESD bench top

- Light grey laminate surface
- Grey edging
- Thickness 25 mm
- Semi-conductive (ESD)



TPH uprights

## 1. Lower shelf AT

Name	Size W x D mm	Max load kg	Code
Lower shelf	1080 x 500	50	AT 120TPH
Lower shelf	1380 x 500	50	AT 150TPH
Lower shelf	1680 x 500	50	AT 180TPH

The lower shelf for TPH bench simply hangs on the horizontal bars.



## 2. Lower steel shelf LSS

Name	Size W x D mm	Max load kg	Code
Lower shelf	1418 x 460	30	LSS150
Lower shelf	1718 x 460	30	LSS180
Low M-divider hoops (4 pcs/set)	460 x 315		LDH

Hangs on the horizontal bars. Can be equipped with steplessly adjustable low M-divider hoops.



### 3. Side worktop

Name	Size W x D mm	Max load kg	Code
Side worktop	400 x 700	35	TP704 ST
Side worktop	400 x 900	35	TP904 ST

Easy to fix to the legs of the bench. Can be fixed on the left or right side of the bench and brackets placed either above or underneath. Height adjustable 575-900 mm from the floor.



### Corner workbench TPH KK

Bench size W x D mm	Max load kg	Code	Code ESD
1100 x 1100	150	TPH707 KK	TPH707 KK ESD
1300 x 1300	150	TPH909 KK	TPH909 KK ESD

A corner workbench can be used with two TPH benches (with one H-frame pair) to create a 90 °angle setup. TPH KK unit consists of a worktop, two H-frames and a leg in the middle. Front side 565 mm.

TPH715\*

TPH707 KK

TPH715\*



\* Workbench with one H-frame pair.



### Accessories from page 90

Superior range of accessories available for ergonomic TPH workstation.



# TPB packing benches



See the ready-made configurations of the bench in our [3D Configurator!](#)



**This packing table adapts and grows according to your needs.** You don't need to know what your business will look like in two years' time, as you can add and remove accessories as you go. Start small and add from over 50 accessories based on your needs. TPB comes in one flat pack and is easy to assemble. Perfect packing table option for cost-conscious users.

Carefully selected materials, high-quality finishing, epoxy powdercoated steel parts. Laminate bench top, 25 mm low-pressure laminate. Stepless height adjustment with allen-key between 650-900 mm.



300 kg

- Safe, economic and ergonomic all-in-one choice
- Adapts and grows according to needs
- 50+ accessories and add-on products available
- One flat pack contains all the basic equipment
- Easy to buy, transport and assemble

## ACCESSORIES ON PAGE 90

Essential range of accessories available for ergonomic TPB packing bench



**READ MORE ABOUT**  
Treston packing benches  
from our separate brochure.



[treston.com/catalogues-and-brochures](http://treston.com/catalogues-and-brochures)

# Designing TPB packing station

- The TPB packing bench comes with a full set of basic accessories. The package includes 2 roll holders, perforated panel, upper steel shelf, divider hoops and an auxiliary steel shelf.
- Further customize with additional accessories

### Packing bench TPB

Size W x D mm	Max load kg	Code
1500 x 900 x 650-900	300	TPB915
1800 x 900 x 650-900	300	TPB918

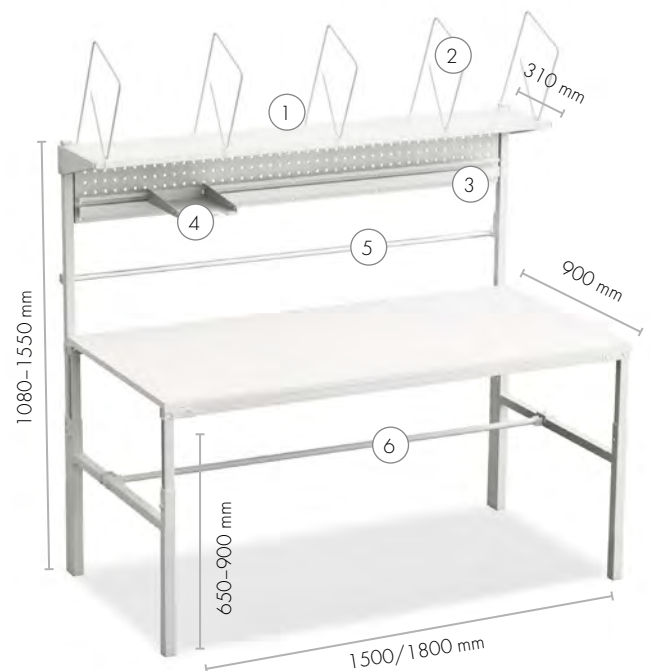

### Accessories from page 90

Essential range of accessories available for ergonomic TPB packing bench

### Packing bench TPB915/TPB918 includes:

Name	Description	Code TPB915	Code TPB918
1. Height adjustable upper steel shelf	Size 310 x 1500/1800 mm. Max load 30 kg. Fixing positions for Treston lighting units under the shelf.	SS150	SS180
2. Adjustable divider hoops	Five adjustable divider hoops (height 400 mm).	PDH	PDH
3. Height adjustable steel perforated panel with bin rail	Size of the panel 1419/1719 x 255 mm. For auxiliary steel shelves and stacking bins. Max load 20 kg.	PP150	PP180
4. Auxiliary steel shelf	Size 217 x 298 x 20 mm, for A4 paper and tape dispensers (max 2 pcs per shelf). Max load 3 kg.	ASSA4	ASSA4
5. Upper paper roll holder	Height adjustable. Axle diameter 25 mm. Max roll width 1400/1700 mm. Max load 40 kg.	PRH ROLL150	PRH ROLL180
6. Lower paper roll holder	Simply hangs on horizontal bars of legs. Depth adjustable. Axle diameter 25 mm. Max roll width 1350/1650 mm. Max load 40 kg.	PRHL ROLL150	PRHL ROLL180

### Lower steel shelf LSS

Name	Size W x D mm	Max load kg	Code
Lower shelf	1418 x 460	30	LSS150
Lower shelf	1718 x 460	30	LSS180
Low M-divider hoops (4 pcs/set)	460 x 315		LDH

Hangs on the horizontal bars. Can be equipped with steplessly adjustable low M-divider hoops.



### Side worktop

Name	Size W x D mm	Max load kg	Code
Side worktop	400 x 900	35	TP904 ST

Easy to fix to the legs of the bench. Can be fixed on the left or right side of the bench and brackets placed either above or underneath. Height adjustable 575-900 mm from the floor.



# Industrial workbenches



See the ready-made configurations of the bench in our [3D Configurator!](#)

**The industrial workbenches are sturdy models that can withstand the heavy wear and tear of heavy industry.**

They are a good choice for workshops, automotive and other repair shops, maintenance units, and challenging environments in which chemicals or heavy loads are handled on a daily basis.

Choose Heavy workbench or Heavy Duty workbench and build the combination that best meet your needs.



Heavy Duty workbench on the left and Heavy workbench on the right



1000 kg



550 kg

- Sturdy benches that can withstand the heavy wear and tear of heavy industry
- Loading capacity for the Heavy workbench up to 550 kg; for the Heavy Duty workbench up to 1000 kg; with castors: up to 550 kg
- You can build your personal workstation with our wide range of accessories.

## ACCESSORIES ON PAGE 69

Superior range of accessories available for industrial workbenches

# Industrial workbench examples



## 1. Heavy workstation 1

Qty	Name	Size mm	Code
1	Heavy workbench, vinyl top	2000 x 630	HWB20063V
3	Upright tube	1359	860 024-49
2	Perforated panel M1000	968 x 1003	861 535-07
2	Drawer unit 45/26-1	450 x 520 x 260	604 49 001

## 2. Heavy workstation 2

Qty	Name	Size mm	Code
1	Heavy workbench, steel top	1500 x 630	HWB15063S
3	Upright tube	1359	860 024-49
1	Perforated panel M750	718 x 1003	861 514-49
3	Steel shelf M750	740 x 400	852 770-49

## 3. Heavy Duty repair workstation

Qty	Name	Size mm	Code
2	Adjustable leg		836 664-18
1	Steel bench top	1500 x 750	836 721-18
3	Upright tube	30 x 60 x 996	860 367-18
2	Perforated panel	718 x 612	861 512-18
1	Drawer unit 53/36	530 x 640 x 360	5336 004-18
1	Fixing frame	1500	860 375-18

## 4. Heavy Duty workstation

Qty	Name	Size mm	Code
1	Steel bench top	1500 x 750	836 721-74
1	Adjustable leg		836 664-49
1	Fixing frame	1500	860 375-49
3	Upright tube	1359	860 024-49
1	Light/balancer rail	2 x M750	918 49 006P
1	Treston NaturLite LED 1200	1180	TNL1200
2	Steel shelf	M750 x 300	836 028-49
2	Bin rail	M750	859 151-41
5	Stacking bin	149 x 250 x 130	1525-5
7	Stacking bin	105 x 165 x 75	1015-5
1	Perforated tool cabinet	M750	852 629-07
1	Drawer unit 53/66	530 x 640 x 800	5366 201-07



Some combinations are also available in black. See the products on our website.

# Designing a Heavy duty workstation

- Select the appropriate bench top: steel, vinyl or wood.
- Select a support for both ends of the bench top: adjustable or fixed leg or a drawer unit. Legs with castors are also available
- Use a spacer bar to stabilise the bench.
- An accessory frame can be used instead of a spacer bar if upright tubes are specified.

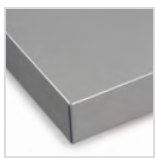

### Steel top 1,5 mm

- Epoxy powder coated dark-grey surface
- Grey plastic ends
- Plywood and chipboard core
- Pre-drilled holes for fixing legs and drawer units
- 3 mm steel top available on request
- Thickness 50 mm



### Vinyl top with steel edges

- Grey vinyl surface
- Galvanized steel front edge
- Plywood and chipboard core
- Pre-drilled holes for fixing legs and drawer units
- Thickness 50 mm



### Multiplex wooden top

- Beech multiplex, treated with linseed oil
- Pre-drilled holes for fixing legs and drawer units
- Thickness 40 mm



### Vinyl top with plastic edges

- Grey vinyl surface
- Grey plastic edging
- Plywood and chipboard core
- Pre-drilled holes for fixing legs and drawer units
- Thickness 50 mm

## Heavy duty bench tops

Bench top Size W x D mm	Steel top 1,5 mm	Max load kg	Steel top 3 mm	Max load kg	Vinyl top with steel edges	Max load kg	Vinyl top with plastic edges	Max load kg	Wood top	Max load kg
1000 x 750	836 720-74	1000	852 652-74	1000	836 723-79	750	836 729-79	750	836 720-82	600
1500 x 750	836 721-74	1000	852 653-74	1000	836 724-79	750	836 726-79	750	836 721-82	600
2000 x 750	836 736-74	1000	852 654-74	1000	836 728-79	750	836 730-79	500	836 736-82	360
2250 x 750	836 722-74	750	852 649-74	750	836 725-79	500	836 727-79	500	836 722-82	360

## Heavy duty bench legs

Name	Height mm*	Code
Adjustable H-leg (1 pc)	700-950	836 664-49
Fixed H-leg (1 pc)	800	836 303-49
Adjustable H-leg for castors (1 pc)	730-950	836 029-49
Swivel castor with brake** (1 pc)	Ø100	1987
Fixed castor** (1pc)	Ø100	1988

\* Height without bench top (including 100 mm castors).

\*\* Max load: 1000/1500 mm wide benches 550 kg, 2000/2250 mm wide benches 300 kg.



Legs with castors are also available

## Spacer bar for Heavy duty bench

Width mm	Code
1000-1500	852 694-49
1500-2250	836 451-49

Spacer bar is used to stabilise the bench. It is necessary if the bench consists only of legs and bench top.



**Accessory frame for Heavy duty bench**

Width mm	Code
1000	852 693-49
1500	860 375-49
2000	860 725-49
2250	860 376-49

Accessory frame is needed if the bench is equipped with upright tubes. Replaces the spacer bar.



**Lower shelves for Heavy duty bench**

Name	Size W x D mm	Max load kg	Code
Lower shelf for Heavy duty bench 1000	870 x 648	200	924 49 021
Lower shelf for Heavy duty bench 1500	1370 x 648	200	924 49 014
Lower shelf for Heavy duty bench 2000	1870 x 648	100	924 49 015
Lower shelf for Heavy duty bench 2250	2120 x 648	100	924 49 018

The lower shelves include a backstop.

Suitable for fixed and adjustable legs.



# Designing a Heavy workstation

- Two worktop options for Heavy workbench: 1,5 mm steel top or vinyl top
- Basic frame includes adjustable legs. A castor mounting set and castors are available as accessories.
- Choose frame with one leg when drawer unit 45 with base (see page 137) is used as a another leg for the table.
- Bench height with drawer unit as a leg: 825 mm for vinyl top and 805 mm for steel top.

**Heavy workbench**

Name	Size W x D mm	Max load kg	Code
Heavy workbench, steel top	1500 x 630	550	HWB15063S
Heavy workbench, steel top	2000 x 630	550	HWB20063S
Heavy workbench, vinyl top	1500 x 630	450	HWB15063V
Heavy workbench, vinyl top	2000 x 630	450	HWB20063V
Castor mounting set			890781-49
Swivel castor with brake* (1 pc)	Ø100		1987
Fixed castor* (1pc)	Ø100		1988

\* Max load: 1500 mm wide benches 550 kg, 2000 mm wide benches 300 kg.



**Heavy workbench with one leg**

Name	Size W x D mm	Max load kg	Code
Heavy workbench, steel top, one leg	1500 x 630	550	HWB15063S-SL
Heavy workbench, steel top, one leg	2000 x 630	550	HWB20063S-SL
Heavy workbench, vinyl top, one leg	1500 x 630	450	HWB15063V-SL
Heavy workbench, vinyl top, one leg	2000 x 630	450	HWB20063V-SL

With these items, a 45/66 drawer unit with a base is required as the second leg of the table.





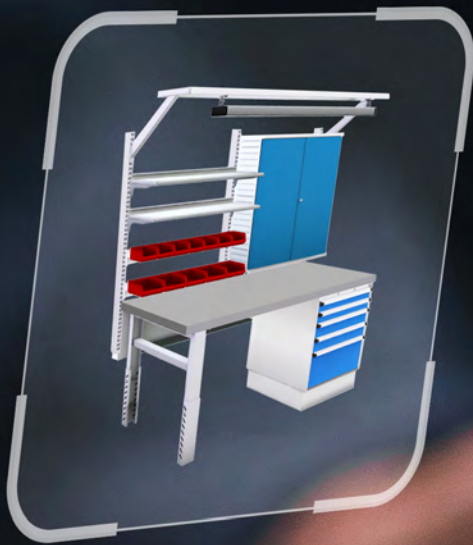

# Looking for ideas?

Check out our new library with ready-made workbench 3D designs!

[3d.treston.com](http://3d.treston.com)



## 2. Workbench accessories



# Accessories for Concept Ergo, QuatreX, TED, Quick Edge, TP and Industrial workbenches

Our Concept Ergo, Concept, QuatreX, TED, Quick Edge, TP, and Industrial workbenches can be fitted with the same accessories and they are interchangeable. Many accessories are also compatible with our trolleys and cabinets. Upright tubes are the basic element for accessorising our industrial furnishings. Accessories are attached to Concept Ergo, Concept, QuatreX, TED, TP and Industrial workbenches with the aid of upright tubes or a complete, upright tube module.

For the Concept Ergo, Concept and QuatreX bench, the upright tubes are attached to the rear case of the bench with the fixing plates or screws that are delivered with the bench. With the TP bench, you also need an accessory frame TPK (page 54), which also includes the fixing plates for the upright tubes. For the TED bench, upright tube pair with a flange is fitted on worktop with screws.

## Upright tubes

Name	Size W x D mm	Length (l) mm	Code
Upright tube	30 x 60	500	860 991-49
Upright tube	30 x 60	800	860 142-49
Upright tube	30 x 60	996	860 367-49
Upright tube	30 x 60	1359	860 024-49
Upright tube	30 x 60	1582	860 025-49
Horizontal profile	M500		HPM500-49
Horizontal profile	M750		HPM750-49
Horizontal profile	M900		HPM900-49
Horizontal profile	M1000		HPM1000-49
Horizontal profile	M1200		HPM1200-49
Horizontal profile	M1350		HPM1350-49
Horizontal profile	M1500		HPM1500-49
Horizontal profile	M1800		HPM1800-49
Horizontal profile	M2000		HPM2000-49
Fixing plug set (2 pcs)			FPSET

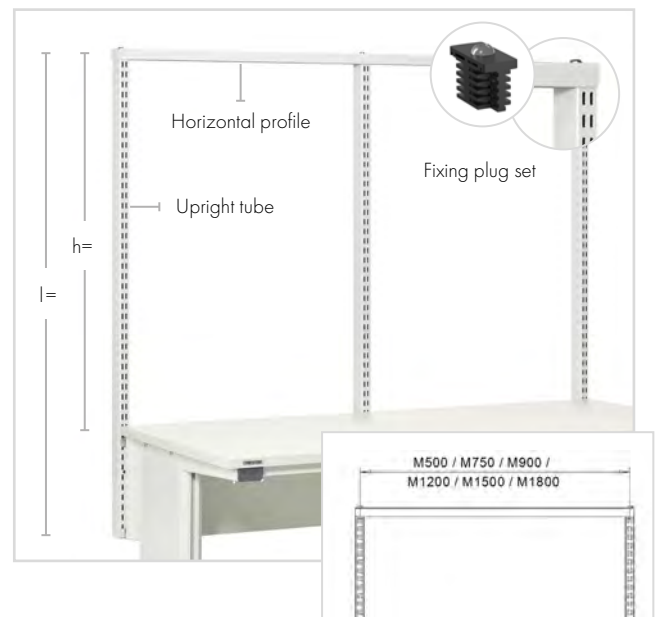

## Upright tube modules and compatibility

Suitable for bench widths						Code S	Code M	Code L
C = Concept Ergo & Concept, TP = TP, Q = QuatreX						l = 996 mm h = 683 mm*	l = 1359 mm h = 1046 mm*	l = 1582 mm h = 1269 mm*
	1000	1200	1500	1800	2000			
1 x M750	C	C/TP	C	C	C	UTM1X750S-49	UTM1X750M-49	UTM1X750L-49
1 x M900	C/TP	C/TP	C	C	C	UTM1X900S-49	UTM1X900M-49	UTM1X900L-49
1 x M1200		C/TP/Q				-	UTM1X1200M-49	-
1 x M1500			C/TP/Q	C	C	-	UTM1X1500M-49	-
1 x M1800				C/TP/Q	C/Q	-	UTM1X1800M-49	-
2 x M500	C/Q	C				UTM2X500S-49	UTM2X500M-49	UTM2X500L-49
2 x M750			C/TP/Q	C	C	UTM2X750S-49	UTM2X750M-49	UTM2X750L-49
2 x M900				C/TP/Q	C/Q	UTM2X900S-49	UTM2X900M-49	UTM2X900L-49
3 x M500			C/TP/Q	C		UTM3X500S-49	UTM3X500M-49	UTM3X500L-49
4 x M500					C/Q	UTM4X500S-49	UTM4X500M-49	UTM4X500L-49

\*h = module's height measured from bench's top surface.

Load capacity 100 kg / module spacing. With QuatreX the total load capacity of the upright structure is 150 kg.

Upright tube module includes upright tubes, horizontal profile, fixing plugs, and 5 pcs of cable clips for easy cable management.

The modular (M) size refers to the distance between two upright tubes from the middle of the tube. The modular size is used to find the appropriate accessories.



Upright tube pair with a flange for TED

## Upright tube pair with a flange for TED

Size W x D x H mm	Code
70 x 100 x 418	TTP400-49
70 x 100 x 793	TTP790-49
70 x 100 x 997	TTP990-49

Load capacity 80 kg.

## Aluminium bracket

Name	Code
Aluminium bracket	846 554-00

A separate aluminium bracket can be used to attach a single tube to any bench.



Aluminium bracket

# Light and balancer rail

Apart from the Treston Wave LED ESD and Naturlite LED Wing 500 all luminaires are fitted to light/balancer rails which are height and depth adjustable. Tool balancer rails and sliding pieces facilitate the use of heavy equipment. A tool balancer is fixed to the light/balancer rail.

## Light and balancer rail (includes one sliding piece)

Modular size	Width of the front profile mm	Max load kg	Code
2 x M500	1000	15	918 49 001P
2 x M500/1500	1500	15	918 49 002P
4 x M500	2000	15	918 49 003P
M750	750	15	918 49 004P
M750/900	900	15	918 49 013P
M750/1500	1500	15	918 49 005P
2 x M750	1500	15	918 49 006P
3 x M750	2250	15	918 49 012P
M900	900	15	918 49 007P
2 x M900	1800	15	918 49 008P
M900/1500	1500	15	918 49 009P
M1200	1200	15	918 49 010P
M1350	1350	15	918 49 011P

With extension benches you also need a center bracket, code 890 789-49



Lighting solutions from page 102.



Center bracket

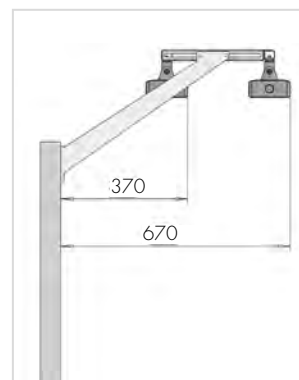
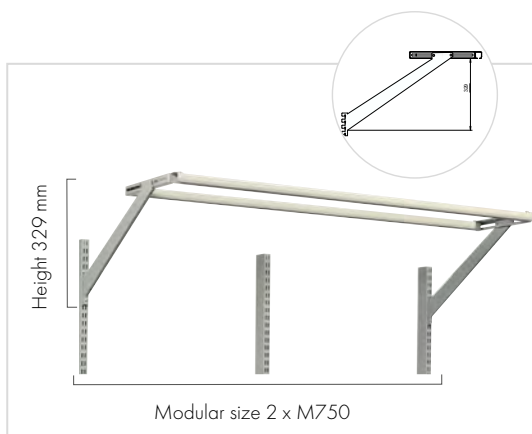
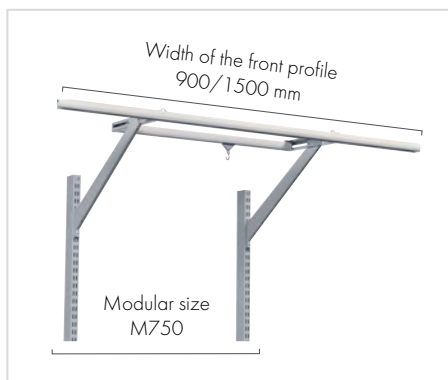

## Tool balancers and other supplies

Name	Tool weight kg	Code
Tool balancer 2DU	0,5 - 1	939 502-00
Tool balancer 4DU	1 - 2	939 503-00
Sliding piece with a snap hook		890 788-51



Tool balancer

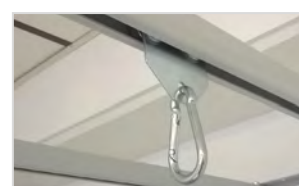

Sliding piece with a snap hook

# Power rails

Power rails come with brackets for fixing to Treston workstations. Rails can be fixed vertically on upright or aluminum profile, horizontally on aluminum profile or on M750 and M900 modules between uprights. With a new bracket set rails can also be fixed straight to table top or perforated panel. Power rail can be mounted on four different angles on brackets. Length of the rail can limit the mounting possibilities.

## Power rails

Description	Length	Code
3 sockets + 2 x USB	331	TPR3-001
6 sockets + switch + 2 x USB	468	TPR4-001
6 sockets + switch + 2 x USB + 2 x CAT6A	468	TPR4-003
4 sockets + switch + fault current protection	468	TPR4-004
6 sockets + switch	468	TPR4-005
5 sockets + switch + 2 x USB	683	TPR7-001
5 sockets + switch + 2 x USB + 2 x CAT6A	683	TPR7-003
4 sockets + switch + fault current protection + 2 x USB	683	TPR7-008
10 sockets + switch	683	TPR7-038
6 sockets + switch + 2 x USB	836	TPR9-001
6 sockets + switch + 2 x USB + 2 x CAT6A	836	TPR9-003
6 sockets + switch + fault current protection + 2 x USB	836	TPR9-010
12 sockets + switch	836	TPR9-276
6 sockets + switch + 2 x USB	1400	TPR14-001
6 sockets + switch + fault current protection + 2 x USB	1400	TPR14-010
6 sockets + switch + 2 x USB	1700	TPR17-001
6 sockets + switch + fault current protection + 2 x USB	1700	TPR17-010



TPR3-001



TPR4-001



TPR7-001



TPR9-001



TPR14-001



Further info and images on power rails on page 98.

## Distributor for compressed air

Name	In	Out	Fixing	Code
Distributor for compressed air	1	2	vert.	859 861-00
All connections are 3/8"				
Can be fitted to all Treston benches.				

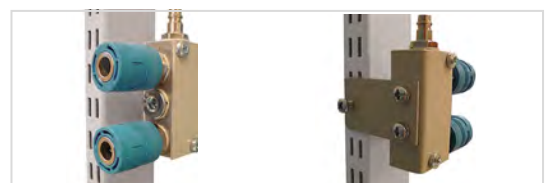

Distributor for compressed air

# Shelves

## Tiltable top shelf TTS

Module	Size W x D mm	Max load kg	Code
M500	467 x 300	80	TTSM5003-49
M500	467 x 400	80	TTSM5004-49
M750	717 x 300	80	TTSM7503-49
M750	717 x 400	80	TTSM7504-49
M900	870 x 300	80	TTSM9003-49
M900	870 x 400	80	TTSM9004-49
M1000	967 x 300	80	TTSM10003-49
M1000	967 x 400	80	TTSM10004-49
M1200	1167 x 300	80	TTSM12003-49
M1200	1167 x 400	80	TTSM12004-49
M1350	1320 x 300	80	TTSM13503-49
M1350	1320 x 400	80	TTSM13504-49
M1500	1467 x 300	80	TTSM15003-49
M1500	1467 x 400	80	TTSM15004-49
M1800	1773 x 300	80	TTSM18003-49
M1800	1773 x 400	80	TTSM18004-49
M2000	1973 x 300	80	TTSM20003-49
M2000	1973 x 400	80	TTSM20004-49

Max. tilt 20 degrees (depth 300 mm) or 12,5 degrees (depth 400 mm). Front lip height 30 mm. Can also be installed at the back of the shelf.



Tiltable top shelf M500, M750, M900, M1000, M1200, M1350, M1500, M1800, M2000

## Accessory box for under TTS-shelf

Suitable for	Size D x H mm	Code
Tiltable top shelf TTS depth 300 mm	220 x 300	ABTTS3-41
Tiltable top shelf TTS depth 300 mm	220 x 300	ABTTS3-49
Tiltable top shelf TTS depth 400 mm	220 x 370	ABTTS4-41
Tiltable top shelf TTS depth 400 mm	220 x 370	ABTTS4-49

Includes a blue (-41) or a black ESD (-49) 3020 or 4020 bin.

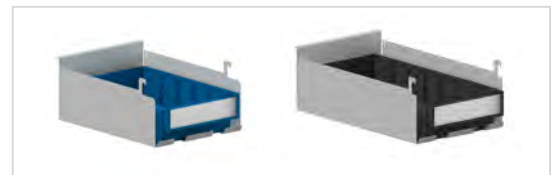

Accessory box for under TTS-shelf

## Steel shelf

Module	Size W x D mm	Max load kg	Code
M500	490 x 300	50	860 804-49
M500	490 x 400	50	860 805-49
M750	740 x 300	50	836 028-49
M750	740 x 400	50	852 770-49
M900	890 x 300	50	852 283-49
M900	890 x 400	50	852 769-49
M1000	990 x 300	50	890 631-49
M1000	990 x 400	50	890 632-49
M1350	1340 x 300	50	860 787-49
M1350	1340 x 400	50	860 788-49
M1500	1490 x 300	50	890 756-49
M1500	1490 x 400	50	890 757-49



Steel shelf M500, M750, M900, M1000, M1350, M1500



**Due to the dual-purpose shelf brackets,** the steel shelf can be used either as tilted 20° or in a horizontal position. The shelf has an integrated edge, which can be used either in the front or back of the shelf, depending on the use of the shelf.

**Divider hoops set (4 pcs)**

Suitable for	Size D x H mm	Code
Tiltable top shelf TTS depth 300 mm	300 x 400	PDH300-49
Tiltable top shelf TTS depth 400 mm	400 x 400	PDH400-49



Divider hoops set

**Divider pair**

Suitable for	Size D x H mm	Code
Steel shelf depth 300 mm	285 x 190	010 004-49
Steel shelf depth 400 mm	385 x 190	010 005-49
Tiltable top shelf TTS depth 300 mm	285 x 190	861 116-49
Tiltable top shelf TTS depth 400 mm	385 x 190	861 118-49



Divider pair

**Adjustable shelf**

Module	Size W x D mm	Max load kg	Code
M500	470 x 505	100	920 49 001P
M500	470 x 650	100	920 49 002P
M750	720 x 505	100	920 49 005P
M750	720 x 650	100	920 49 006P
M900	870 x 505	100	920 49 009P
M900	870 x 650	100	920 49 010P
M1350	1320 x 505	100	920 49 013P
M1350	1320 x 650	100	920 49 014P

Also available as non ESD-versions (code 41 instead of 49).

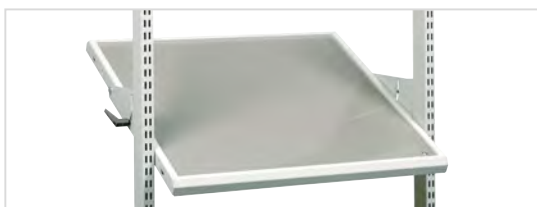

Adjustable shelf, tilting 0-25°

**Adjustable shelf, stepless depth adjustment**

Module	Size W x D mm	Max load kg	Code
M500	470 x 505	50	920 49 003P
M500	470 x 650	50	920 49 004P
M750	720 x 505	50	920 49 007P
M750	720 x 650	50	920 49 008P
M900	870 x 505	50	920 49 011P
M900	870 x 650	50	920 49 012P

Also available as non ESD-versions (code 41 instead of 49).



Steplessly adjustable shelf, tilting 0-25°

**+** Additional adjustable shelves on page 127.

**Pull-out steel shelf**

Module	Size W x D mm	Max load kg	Code
M750	720 x 390	30	925 49 002
M900	870 x 390	30	925 49 003

Shelf can be slid out 100%



Pull-out steel shelf

**Document shelf**

Module	Size W x D mm	Max load kg	Code
M500	470 x 265	5	860 806-49
M750	720 x 265	5	860 115-49
M900	870 x 265	5	860 399-49



Document shelf, tilting 10 - 75°

**Flow-through shelf**

Module	Size W x D mm	Max load kg	Code
M750	718 x 830	150	890 710-49

A flow-through shelf can fit two 400 mm deep bins in depth direction.

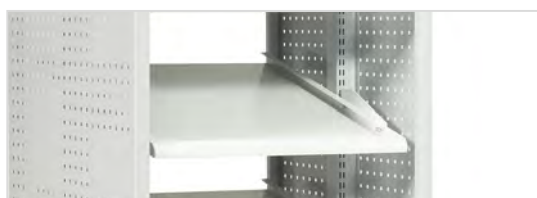

Flow-through shelf

# Upright accessories

## Adjustable auxiliary shelf

Name	Size W x D mm	Tilting	Max load kg	Code	Code ESD
Adjustable auxiliary shelf	560 x 340	0-25°	15	927 41 001P	927 49 001P
Adjustable auxiliary shelf	605 x 405	0-25°	15	927 41 002P	927 49 002P



Adjustable auxiliary shelf

## IT shelves and trays

Name	Size W x D x H mm	Max load kg	Code
Laptop / printer shelf	365 x 365	25	930 49 001P
Keyboard tray for laptop shelf	480 x 270	5	860 904-49
Keyboard and mouse tray for laptop shelf	620 x 270	5	860 903-49
Keyboard tray (attached to the bench top)*	680 x 375 x 106 (outer) 620 x 305 x 90 (inner)	10	925 49 001P



Laptop/printer shelf with arm



Keyboard tray (attached to the bench top)

\* Suitable also for WB, TP, TPH and TPB benches.

## Holder for Thin Client PC

Name	Size W x D x H mm	Max load kg	Code
Holder for Thin Client PC	250 x 45-65 x 145	5	TCH

Fixed to keyboard tray 860941-49 or 860942-49.



Holder for Thin Client PC

## LCD monitor holder for perforated panel

Name	Max load kg	Code
LCD monitor holder for perforated panel	10	890 715-49

Suitable for VESA 75/100



LCD monitor holder for perforated panel

## Display bracket for light duty for TED desk

Name	Suitable for	Max load kg	Code
Display bracket for light duty for TED desk	TED	7	TDB-49

Suitable for VESA 75/100



Display bracket for light duty

## LCD holder with double arm

Name	Size W x D x H mm	Max load kg	Code
LCD holder with double arm*		15	930 49 002P
Keyboard tray for LCD holder	480 x 260	5	860 941-49
Keyboard and mouse tray for LCD holder	620 x 260	5	860 942-49

Fixed to keyboard tray 860941-49 or 860942-49.

\* Suitable for VESA 75/100



LCD holder with double arm

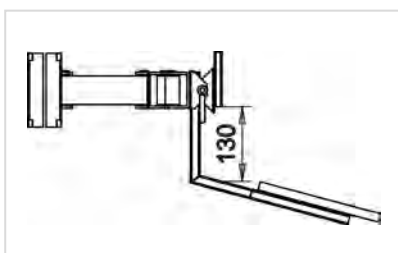

Maximum distance between the LCD holder and keyboard tray



LCD-holder & keyboard tray

**Equipment tray**

Name	Size W x D mm	Max load kg	Code	
Equipment tray	250 x 250 x 90	10	928 49 001P	
Equipment tray	500 x 250 x 125	15	928 49 002P	
Equipment tray *	500 x 250 x 125	30	928 49 003P	

\*Comes with heavy arm.



Equipment tray

**Bin shelf**

Name	Size W x D mm	Max load kg	Code	
Bin shelf	560 x 175 x 125	15	928 49 005P	
Bin shelf	600 x 220 x 125	15	928 49 006P	
Stand for picking bins**	560 x 165 x 355		860 113-49	

\*\*Space for 15 picking bins 30-1L-4ESD



Bin shelf



Stand for stacking bins

**Document holders**

Name	Size W x D mm	Max load kg	Code	
Document holder A4	290 x 330	5	928 49 008P	
Document holder A3	418 x 330	5	928 49 009P	



Document holder

**Tool panel**

Name	Size W x D mm	Max load kg	Code	
Tool panel	267 x 305	5	928 49 010P	



Tool panel

**Bin rails with arms**

Name	Size W x D mm	Max load kg	Code	Code ESD
Curved bin rail with arm	770 x 54	15	929 41 002P	929 49 002P
Extension for curved bin rail with arm	770 x 54		860 911-41	860 911-49



Curved bin rail with arm ESD



Extension for curved bin rail with arm ESD

**Rotating tool frame**

Name	Size W x D mm	Max load kg	Code
Rotating tool panel frame, height-adjustable arm	513 x 320	15	860 864-49P
Rotating tool panel frame, double arm	513 x 320	15	880 865-49P

The rotating tool panel frame can be equipped with perforated panels and tool troughs. The rotating tool frame is compatible with all M500 accessories, such as the tool trough and the bin rails.



**Rotating tool panel frame with double arm**

**Accessories for rotating tool frame**

Name	Size W x D mm	Max load kg	Code	Code ESD
Perforated panel	470 x 300			860 951-49
Tool trough M500	470 x 150			860 952-49
Bin rail M500	492 x 90	15*	859 150-41	859 150-49
Light bin rail M500	492 x 54	10	860 953-41	860 953-49
Aluminium bin rail M500 for rotating tool panel	486 x 55 x 75	15	BP500C	
Auxiliary steel shelf	217 x 330 x 50	3		ASSA4
Auxiliary steel shelf	159 x 254 x 50	2		ASSA5

\*Actual bin rail max load 40 kg but with arm 15 kg.



**Rotating tool panel frame with M500 perforated panel, aluminium bin rail M500 and auxiliary steel shelf**

**Replacement arms (spare parts)**

Name	Length mm	Max load kg	Code
Double arm, 40 mm	200+200	10	880 020-49
Double arm, 60 mm	200+200	15	880 010-49
Heavy arm, 60 mm	287+221	30	860 993-49
Height-adjustable arm with gas spring, 60 mm (height adjustment range 165 mm)	375	15	860 985-49
Height-adjustable profile	55 x 80 x 590	15	860 997-49P

LCD screen holder for 60 mm double, heavy or height adjustable arms: 860940-49.



**Double arm**



**Heavy arm**



**Height-adjustable arm**



**Height-adjustable profile**

**When a position changes, the height must be adjusted**

Frequent changes in the working position, such as changing from a sitting position to a standing position, require height-adjustable arm (860 985-49). The height-adjustable profile (860 997-49) can be attached to any rack with arm (such as the PC rack) that is pulled down and lifted back up according to the working position. The adjustment range is 450 mm.

**Arm adapters for Concept Ergo, Concept, QuatreX, TED, Quick Edge, TP and Heavy duty accessories with arms**

Profile type	Workbench / trolley model	40 mm arm	60 mm arm
C-profiles	TPH, TPB	-	E824 081-49
AL2X aluminium profiles	WB, QuatreX	890 524-49	890 525-49
Aluminium profiles	WTR	E821 573-49	E821 572-49

Arm accessories for upright tubes can be used in other profile types with adapters.



**Auxiliary top, fixed brackets**

Name	Size W x D mm	Max load kg	Code	Code ESD
Auxiliary top left	400 x 500	40	926 41 001P	926 49 001P
Auxiliary top right	400 x 500	40	926 41 002P	926 49 002P



Auxiliary top

**Bottle holder**

Name	Code
Bottle holder (Ø 100) for upright tube	859 063-49



Bottle holder

**Roll holder for upright tube**

Name	Code
Roll holder for upright tube (roll ø height 150 mm, width 320 mm)	860 841-49



Roll holder

**Adapter set AS**

Name	Suitable for	Code
Adapter set for perforated upright tubes*	MH / MA / MA2	AS2
Adapter for perforated upright tubes	MA4	AS4

The above adapter set/adapters are needed for fixing MH/MA/MA2/MA4 to upright tubes.

\* AS2 is also suitable for TPH/TPB C-profiles.



Adapter set AS2

Adapter AS4

**LCD bracket MH**

Name	Max load kg	Suitable for	Code
LCD bracket MH	15	Upright tubes + AS2	MH

The quick-release mechanism is equipped with the standard used flat-screen mount 75 x 75 and 100 x 100 for the mounting of all normal flat-screens.



LCD bracket MH

LCD swivel arm MA

**LCD swivel arm MA**

Name	Max load kg	Suitable for	Code
LCD swivel arm MA	10	Upright tubes + AS2	MA

The quick-release mechanism is equipped with the standard flat-screen mount 75 x 75 and 100 x 100 for the mounting of all normal flat-screens. The arm is double articulated, turns through a radius of 180° and will extend between 95-425 mm from the upright.

**LCD swivel arm MA2**

Name	Max load kg	Suitable for	Code
LCD swivel arm MA2	15	Upright profiles + AS2	MA2

The quick-release mechanism is equipped with the standard, widely used flat-screen mount 75 x 75 and 100 x 100 for the mounting of all normal flat-screens. The arm is double articulated, turns through a radius of 180° and will extend between 95-425 mm from the upright.



LCD swivel arm MA2

**LCD screen holder with height adjustable arm MA4**

Name	Max load kg	Suitable for	Code
LCD screen holder MA4	2-7	Upright tubes + AS4	MA4

Highly ergonomic and easily height adjustable monitor arm with a gas spring. Easy mounting of the monitor with a quick-release mechanism, standard flat screen mount 75 x 75 mm and 100 x 100 mm for LCD screens. Cable management by cable clips. The double arm turns through a radius of 180 and will extend between 80-500 mm from the upright.



LCD screen holder MA4

**Tablet bracket MY**

Name	Suitable for	Code
Tablet bracket MY	Requires either an MH, MA, MA2 or MA4 swivel arm.	MY

For 7-10" tablets.



LCD bracket MH + tablet bracket MY

# Packing accessories

## Shelf for packing material SPM

Name	Size W x D x H mm	Max load kg	Suitable for	Code
Shelf for packing material	467 x 600 x 32	60	M500	SPM500-49
Shelf for packing material	717 x 600 x 32	60	M750	SPM750-49
Shelf for packing material	870 x 600 x 32	60	M900	SPM900-49
Shelf for packing material	1167 x 600 x 32	60	M1200	SPM1200-49
Shelf for packing material	1317 x 600 x 32	60	M1350	SPM1350-49
Shelf for packing material	1467 x 600 x 32	60	M1500	SPM1500-49
Shelf for packing material	1773 x 600 x 32	60	M1800	SPM1800-49
Adjustable fastening set under worktop	90 x 350 x 355 (free space 285-465 on lower shelf)		SPM-shelves	SPMAF-49
Brackets for upright tube			SPM-shelves	SPMBS-49
Brackets for Treston Quick Edge			SPM-shelves	SPMTQE-49
Divider hoops set (4 pcs)	8 x 400 x 280		SPM-shelves	PDH600-49

The shelf does not include fastening parts.

**SPM shelves aren't suitable for TED electric desk.** Lower shelves for TED on page 43.



Shelf for packing material, adjustable fastening set under worktop and divider hoops



Shelf for packing material and brackets for upright tube

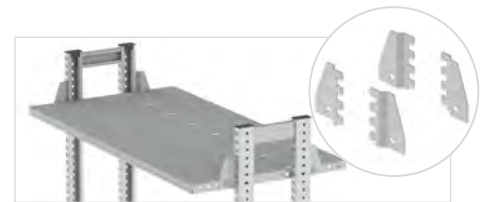

Shelf for packing material and brackets for Treston Quick Edge

## Suitability of lower shelves to 750 and 900 mm deep benches

Concept Ergo 2000/1800: SPM1500 or smaller	QuatreX 2025: SPM1800 or smaller
Concept Ergo 1500: SPM1200 or smaller	QuatreX 1825: SPM1500 or smaller
Concept Ergo 1200: SPM900 or smaller	QuatreX 1525: SPM1200 or smaller
Concept Ergo 1000: SPM500	QuatreX 1225: SPM900 or smaller
	QuatreX 1025: SPM750 or smaller
	SPM-shelves are fixed to Treston QuatreX with SPMAF-49 brackets.

## Roll holders

Name	Max roll length mm	Max load kg	Suitable for	Code
Roll holder set	635	40	M750	890 547-49P
Roll holder set	785	40	M900	890 548-49P
Roll holder set	1080	40	M1200	890 598-49P
Roll holder set	1400	40	M1500	859 041-49P
Roll holder set	1700	40	M1800	859 042-49P
Roll holder set under worktop 1500*	1200	40	M1500	859 044-49P
Roll holder set under worktop 1800*	1500	40	M1800	859 045-49P
Paper roll dividers (2 pcs) Ø 170 mm				RD25

\* Suitable only for Concept hand crank bench.



Roll holder set and paper roll divider



Roll holder set under worktop



Packing material holder for upright tubes

## Packing material holders

Name	Max width of material mm	Suitable for	Code
Packing material holder for upright tubes	635	M750	PMH750-49
Packing material holder for upright tubes	785	M900	PMH900-49
Packing material holder for upright tubes	1080	M1200	PMH1200-49
Packing material holder for upright tubes	1200	M1350	PMH1350-49
Packing material holder for upright tubes	1400	M1500	PMH1500-49
Packing material holder for upright tubes	1700	M1800	PMH1800-49

Handy holder for packing material that can be taken from a roll. Holds material in place during and after cutting. Can hold two different materials at the same time.

**Cutting support for packing material holder**

Name	Suitable for	Code
Cutting support for packing material holder	PMH750-49	CSM750-49
Cutting support for packing material holder	PMH900-49	CSM900-49
Cutting support for packing material holder	PMH1200-49	CSM1200-49
Cutting support for packing material holder	PMH1350-49	CSM1350-49
Cutting support for packing material holder	PMH1500-49	CSM1500-49
Cutting support for packing material holder	PMH1800-49	CSM1800-49

Pull-out, ergonomic cutting support for packing material. The support helps to cut packing material more easily e.g. with a carpet knife. Attached to the PMH packing material holder. Distance from the upright tube 250-400 mm. Pull-out distance 150 mm.



Cutting support for packing material holder

**Pull-out steel shelf for printer**

Name	Size W x D x H mm	Max load kg	Suitable for	Code
Pull-out steel shelf for printer	500 x 510 x 515	35	Concept Ergo, Concept, QuatreX, TP, TPB, TPH	PSP50

Suitable for 750 and 900 deep Concept Ergo / Concept benches.



Pull-out steel shelf for printer

**Printer platform slideable**

Name	Size W x D x H mm	Max load kg	Suitable for	Code
Printer platform slideable	315 x 530	30	Concept Ergo, Concept, QuatreX, Quick Edge	859 060-49



Printer platform slideable

**Fixed tape dispenser**

Name	Suitable for	Code
Fixed tape dispenser	All benches	FTD50

Includes screws to fix the dispenser to ASSA4 (see page 76). Max roll Ø 120 mm and width 50 mm.



Fixed tape dispenser

**Basic label dispenser**

Name	Size W x D x H mm	Suitable for	Code
Basic label dispenser	214 x 128 x 120	All benches	BLD20

Can be fixed with screws. Max roll Ø 220 mm and width 210 mm.



Basic label dispenser

**Recycling material bin**

Name	Size W x D x H mm	Max load kg	Suitable for	Code
Pull-out recycling material bin	286 x 590 x 650	15	Concept Ergo, Concept, TP, TPB, TPH, WB	PRMB3
Recycling material bin	282 x 590 x 600	15	TED, TP, TPB, TPH, WB	PRMB
Recycling material bin	286 x 590 x 600	15	QuatreX	PRMBQX
Recycling material bin	282 x 590 x 600	15	Concept Ergo	PRMBCE



PRMB3



PRMB



PRMBQX



PRMBCE

**Tool tray PTH**

Name	Size W x D mm	Suitable for	Code
Tool tray PTH	1000 x 60	Concept Ergo, QuatreX, TED, WB	PTH100



Tool tray PTH

# Stacking bins and shelf bins

Another way of ensuring an ergonomic working position and saving space is to use bin rails. The higher the rails are, the further they are from the workstation. To ensure an ergonomic working position, use the extension bracket pair on the higher rails. The bin rails are available in six standard module sizes.

Name	Size W x D mm	Max load kg	Code	Code ESD
Bin rail M500	492 x 100	50	859 150-41	859 150-49
Bin rail M750	742 x 100	50	859 151-41	859 151-49
Bin rail M900	895 x 100	50	859 152-41	859 152-49
Bin rail M1000	967 x 100	50	859 156-41	859 156-49
Bin rail M1200	1167 x 100	50	859 157-41	859 157-49
Bin rail M1350	1343 x 100	50	859 153-41	859 153-49
Bin rail M1500	1493 x 100	50	859 154-41	859 154-49
Bin rail M1800	1799 x 100	50	859 155-41	859 155-49
Light bin rail M500	492 x 54	10	860 953-41	860 953-49
Light bin rail M750	742 x 54	10	860 955-41	860 955-49
Light bin rail M900	895 x 54	10	860 956-41	860 956-49
Extension bracket pair	60	50	860 919-41	860 919-49
Aluminium bin rail M500	486 x 55 x 75	40	BP500C	
Aluminium bin rail M750	736 x 55 x 75	40	BP750C	
Aluminium bin rail M900	889 x 55 x 75	40	BP900C	
Aluminium bin rail M1350	1320 x 55 x 75	40	BP1350C	
Aluminium bin rail M1500	1486 x 55 x 75	40	BP1500C	
Aluminium bin rail M1800	1792 x 55 x 75	40	BP1800C	
Auxiliary steel shelf	217 x 330 x 50	3	ASSA4	ASSA4
Auxiliary steel shelf	159 x 254 x 50	2	ASSA5	ASSA5

Light bin rail is recommended only for the small stacking bins.

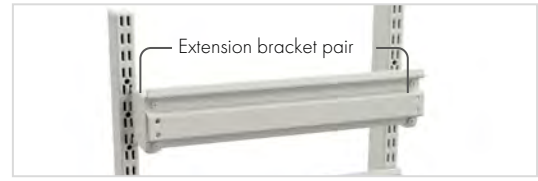

Bin rail with stacking bins



Light bin rail with stacking bins



Aluminium bin rail BP and ASSA4



## Stacking bins

No.	Capacity l	Outer dims W x D x H mm	Inner dims W x D x H mm	Pack pcs	Code.* blue	Code.* red	Code.* ESD black
1.	0,6	105 x 165 x 75	90 x 105 x 65	60	1015-6	1015-5	1015-4 ESD
2.	2,7	149 x 250 x 130	125 x 185 x 115	30	1525-6	1525-5	1525-4 ESD
3.	5,0	186 x 300 x 156	155 x 230 x 140	24	1930-6	1930-5	1930-4 ESD
4.	7,2	186 x 400 x 156	155 x 330 x 140	24	1940-6	1940-5	1940-4 ESD
5.	1,1	99 x 160 x 70	85 x 100 x 62	60	30-1L-6		30-1L-4 ESD
6.	2,2	198 x 160 x 70	175 x 100 x 62	30	30-2L-6		30-2L-4 ESD
7.	2,2	198 x 160 x 70	175 x 100 x 62 (2 fixed length dividers)	30	30-23L-6		30-23L-4 ESD

## Labels and cross dividers

Labels + shields	Pack min. order	Cross divider	Pack pcs
E-10	60		
E-15	30	V-14	30
E-20	24	V-19	24
E-20	24	V-19	24

\* Order number/one item. All bins are also available in grey colour, colour code -3

## Fixing stacking bins on the bin rail

Bin rail	M500	M750	M900	M1350	M1500	M1800	Curved bin rail
1015	4	7	8	12	14	17	
1525	3	5	6	9	10	12	
1930 & 1940	2	4	4	7	8	9	
30-1L	5	7	9	13	15	17	5
30-2L & 30-23L	2	3	4	7	7	9	

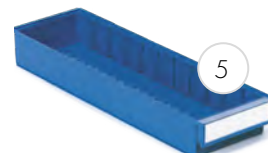
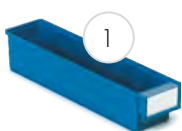

**Shelf bins**

No.	Capacity l	Outer dims W x D x H mm	Inner dims W x D x H mm	Pack pcs	Code* blue	Code.* red	Code.* ESD black	Code* Cross dividers	Number/bin
1.	1,9	92 x 400 x 82	75 x 357 x 70	30	4010-6	4010-5	4010-4 ESD	D-10	6
2.	2,4	92 x 500 x 82	75 x 457 x 70	30	5010-6	5010-5	5010-4 ESD	D-10	8
3.	4,2	186 x 400 x 82	167 x 357 x 70	15	4020-6	4020-5	4020-4 ESD	D-20	6
4.	5,3	186 x 500 x 82	167 x 457 x 70	15	5020-6	5020-5	5020-4 ESD	D-20	8
5.	6,5	186 x 600 x 82	167 x 557 x 70	15	6020-6	6020-5	6020-4 ESD	D-20	10

\*Order number/one item. All bins are also available in grey colour, colour code -3

**Sustainable wood-based bioplastic shelf bins on page 207.**

**Other supplies**

Name	Description	Size W x D x H mm	Code
Stacking bin set	Four bins made of blue polypropylene (PP)	2 pcs 230 x 155 x 140 2 pcs 185 x 125 x 115	SBS4
Tool holder box*	With two blue plastic bins type 3020	400 x 300 x 150	PPH TXL

\* Not suitable for Treston QuatreX workbench.



Stacking bin set



Tool holder box

**+** Entire bin selection on page 205.

# Perforated panels

Name	Module	Size W x H mm	Code
Perforated back panel	M500	468 x 389	861 501-49
Perforated back panel	M750	718 x 194	861 510-07
Perforated back panel	M750	718 x 389	861 511-49
Perforated back panel	M750	718 x 612	861 512-07/-49
Perforated back panel, insulated	M750	718 x 612	861 701-07/-49
Perforated back panel	M750	718 x 1003	861 514-07/-49
Perforated back panel	M900	871 x 389	861 516-49
Perforated back panel	M900	871 x 612	861 517-07/49
Perforated back panel	M900	871 x 1003	861 519-07/49
Perforated back panel	M1000	968 x 389	861 532-49
Perforated back panel	M1000	968 x 612	861 538-07/49
Perforated back panel	M1000	968 x 1003	861 535-07
Perforated back panel	M1200	1168 x 389	861 533-49
Perforated back panel	M1350	1318 x 389	861 521-49
Perforated back panel	M1500	1474 x 389	861 526-49
Perforated back panel	M1800	1774 x 389	861 531-49

Fastened to the upright tubes.

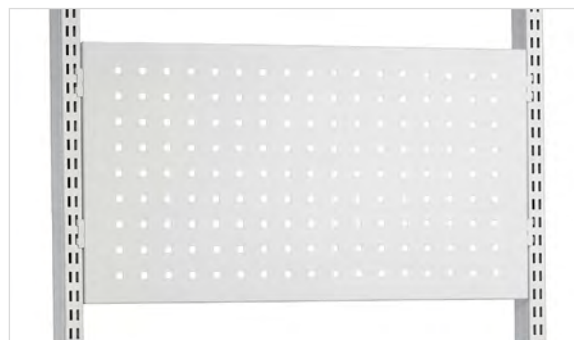

**+** Panel hooks from page 192.

**Auxiliary steel shelf for perforated panel**

Size W x D x H mm	Suitable for	Code
159 x 243 x 56	Perforated panel	ASSA5PP

Auxiliary steel shelf for A5 documents, tape dispenser or handheld scanner. Attached to the perforated panel.



Auxiliary steel shelf for perforated panel

# Small storage solutions

## Perforated tool cabinet

Name	Module size	Size W x D x H mm	Max load kg	Code
Perforated tool cabinet, blue	M500	470 x 250 x 600	20	854 039-07
Perforated tool cabinet, blue	M750	720 x 255 x 900	60	852 629-07
Shelf for M750 perforated tool cabinet		715 x 175 x 15	10	836 273-49

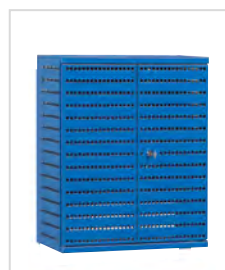

Perforated tool cabinet M500



Perforated tool cabinet M750

## Sliding door cabinet

Name	Module size	Size W x D x H mm	Max load kg	Code
Sliding door cabinet	M750	720 x 370 x 400	40	860 970-49



Sliding door cabinet

## File cabinet

Name	Module size	Size W x D x H mm	Max load kg	Code
File cabinet with two shelves	M750	720 x 330 x 900	60	860 980-49
Shelf + brackets		712 x 296 x 26		860 929-49



File cabinet

## Personal safety equipment cabinet

Name	Module size	Size W x D x H mm	Max load kg	Code
Personal safety equipment cabinet	M750	720 x 330 x 900	60	860 987-07



Personal safety equipment cabinet

## PC/folder box

Name	Size W x D x H mm	Max load kg	Code
PC/folder box, fitted to the upright tubes	130 x 290 x 330	5	860 983-49



PC/folder box

# CPU cabinets and holders

## 1. CPU/printer holder, bar clamp

Size W x D x H mm	Max load kg	Suitable for	Code
>150 x 500 x 85	20	Concept Ergo with accessory bar DBCE	860 551-49



## 2. CPU holder

Size W x D x H mm	Max load kg	Suitable for	Code
180-225 x 450 x 50	20	Concept hand crank	860 552-49



## 3. CPU holder

Size W x D x H mm	Max load kg	Suitable for	Code
180-225 x 450 x 50	20	Concept Ergo	CPUCE-49



## 4. CPU holder

Size W x D x H mm	Max load kg	Suitable for	Code
180-225 x 450 x 50	20	TP upright frame	860 553-49

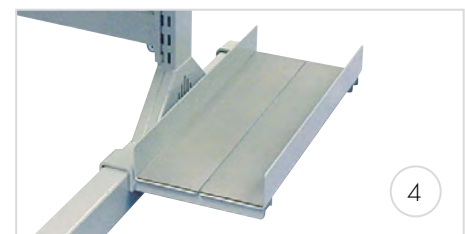

## 5. CPU holder

Size W x D x H mm	Max load kg	Suitable for	Code
180-225 x 450 x 50	20	TP, TPH	854 440-49



## 6. PC stand CPU

Width mm	Height mm	Suitable for	Code
130-240	395-500	WB, QuatreX, TED, TP, TPH, Concept hand crank (depth 750/900 mm), SAP, WTR and Concept trolleys	CPU
340-460	180-285		

An adjustable holder for either vertical or horizontal CPU, to mount underneath the table worktop.



# Cable management

## Cable ducts

Name	Size W x H mm	Suitable for module	Code
Cable duct	467 x 360	M500	860 808-49
Cable duct	717 x 360	M750	860 044-49
Cable duct	870 x 360	M900	860 045-49

Suitable only for Concept Ergo and Concept bench. Fitted to upright tube.

Cable ducts hide the untidy cables from other equipment. This makes it easy to keep the back of the workstation and its surroundings tidy.



Hide wires and cables with a cable duct.

## Horizontal cable troughs

Name	Size W x D x H mm	Suitable for module	Code
Horizontal cable trough	737 x 97 x 45	M750	854 553-49
Horizontal cable trough	890 x 97 x 45	M900	854 554-49
Horizontal cable trough	1187 x 97 x 45	M1200	854 555-49
Horizontal cable trough	1337 x 97 x 45	M1350	890 551-49
Horizontal cable trough	1487 x 97 x 45	M1500	854 556-49
Horizontal cable trough	1793 x 97 x 45	M1800	854 557-49

Horizontal troughs effectively conceal the cables, without preventing maintenance access.



Fitted to upright tubes, the horizontal cable trough enables cables to be hidden at the top of the workstation.



Vertical cable trough

## Vertical cable trough

Name	Size W x D x H mm	Code
Vertical cable trough	52 x 62 x 1360	861 130-49

The vertical cable trough is fitted on the side of the upright tube.

## Treston Cable Tidy

Name	Size W x D x H mm	Suitability	Code
Treston Cable Tidy	800 x 62 x 100	TED	TCT-49

Treston cable tidy hides the cables below the worktop.



Treston Cable Tidy for TED

## CC cable clip set CC5

Name	Suitable for	Code
Cable clip set (incl. 5 pcs)	Upright tubes	CC5

For easy cable management, suitable for up to five cables.



CC cable clip set CC5

# Accessories for WB and Treston QuatreX

## Upright profiles for WB

Size W x H mm	Suitable for	Code	Code ESD
1063 x 900	WB811	AL2X110 W	AL2X110 W
1489 x 900	WB815	AL2X150 W	AL2X150 W
1789 x 900	WB818	AL2X180 W	AL2X180 W

Needed for mounting accessories to WB benches. Includes 2 vertical and 1 horizontal profile. With 3 cable clips (CC8). Load capacity 100 kg/AL2X.

## Upright profiles for Treston QuatreX

Size W x H mm	Suitable for bench widths	Code	Code ESD
1060 x 1200	1025*, 1225	AL2X110QX	AL2X110QX
1489 x 1200	1525	AL2X150QX	AL2X150QX
1789 x 1200	1825, 2025	AL2X180QX	AL2X180QX

Needed for mounting aluminium accessories to the Treston QuatreX bench. Includes 2 vertical and 1 horizontal profile. With 3 cable clips (CC8). Load capacity 150 kg/AL2X.

\* used without a horizontal profile for 700 mm wide accessories (for example ASH70).

## Accessory frame AKK

Size W x D mm	Suitable for	Code	Code ESD
730 x 540	AL2X110 W/QX AL2X150 W/QX AL2X180 W/QX	AKK70	AKK70
690 x 500 + 690 x 500	AL2X150 W/QX	AKK150	AKK150
690 x 500 + 990 x 500	AL2X180 W/QX	AKK180	AKK180

Divides the space between the upright profiles into 2 modules. AKK frame includes 1 vertical and 1 horizontal profile. Useable height 500 mm.

## Support bracket HSB

Length mm	Suitable for	Code	Code ESD
1073	AL2X110 W/QX	HSB110	HSB110
1500	AL2X150 W/QX	HSB150	HSB150
1800	AL2X180 W/QX	HSB180	HSB180

Support bracket of steel for suspending power tools and lighting units. Mount on upright profiles.

## Cable tidy WBCT

Size W x D x H mm	Suitable for	Code	Code ESD
948 x 64 x 204	WB811	WBCT110	WBCT110
1375 x 64 x 204	WB815	WBCT150	WBCT150
1675 x 64 x 204	WB818	WBCT180	WBCT180

Mount on leg frame. We recommend using the cable tidy WBCT with WB Allen-key adjustable benches. The cable tidy is standard equipment on WB C and WB EL models.

## Shelf ALH

Size W x D mm	Suitable for	Code	Code ESD
1073 x 310	AL2X110 W/QX, combination AL2X180 W/QX + AKK180	ALH110	ALH110 ESD
1500 x 310	AL2X150 W/QX	ALH150	ALH150 ESD
1800 x 310	AL2X180 W/QX	ALH180	ALH180 ESD

Height adjustable shelf. 25 mm laminated particle board. Load capacity 50 kg. Mount on upright profiles.

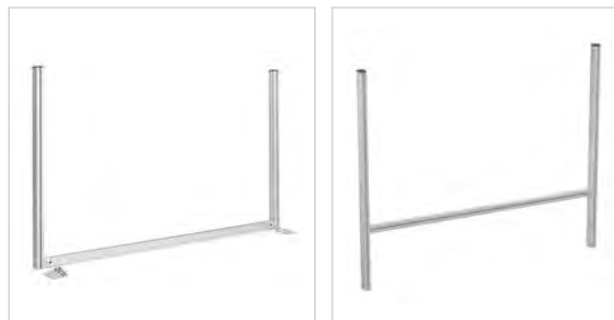

Upright profiles AL2X / AL2XQX



Accessory frame AKK



Support bracket HSB



Cable tidy WBCT



Shelf ALH

**Lower shelf AT**

Size W x D mm	Max load kg	Suitable for	Code	Code ESD
828 x 400	50	WB811	AT110 WB	AT110 WB ESD
1255 x 400	50	WB815	AT150 WB	AT150 WB ESD
1555 x 400	50	WB818	AT180 WB	AT180 WB ESD

Height adjustable lower shelf, 25 mm laminated particle board. Mount between the legs.

**Lower shelf AT**
**Divider hoops PDH**

Height mm	Suitable for	Code	Code ESD
400	ALH	PDH	PDH

Used in combination with shelf ALH. Comes in sets of 5.

**Divider hoops PDH**
**Backstop LIST**

Size W x D x H mm	Suitable for	Code ESD
1400 x 52 x 27	ALH150, ALH 150 ESD, AT150 WB, AT150 WB ESD	LIST150
1700 x 52 x 27	ALH180, ALH180 ESD, AT180 WB, AT180 WB ESD	LIST180

Prevents items from falling off the shelf. Can be fixed on the lower shelf AT or on the shelf ALH.

**Backstop LIST**
**Adjustable shelf ASH**

Size W x D mm	Suitable for	Code	Code ESD
660 x 400	AKK70, AKK150, AKK180	ASH70	ASH70 ESD
960 x 400	AKK180, AL2X110 W/QX	ASH100	ASH100 ESD

Continuous adjustment for depth, height and angle. Shelf of 25 mm laminated particle board. Lipped front edge. Load capacity 35 kg static load. Mount on accessory frame AKK.

**Adjustable shelf ASH**
**Swivel arm with tray AKV**

Size W x D mm	Suitable for	Code	Code ESD
460 x 210 (tray)	AL2X upright profiles	AKV400	AKV400 ESD

Angle adjustable steel tray with swivel radius of 360°. Length of swivel arm 590 mm. Max. load 15 kg.

**Swivel arm with tray AKV**
**Keyboard shelf WKA**

Size W x D mm	Suitable for	Code	Code ESD
500 x 220 (shelf)	AL2X upright profiles	WKA	WKA ESD

Keyboard shelf with swivel arm. Epoxy powder coated steel. Load capacity 15 kg. Arm length 220 mm.

**Keyboard shelf WKA**

**Component rack EPL**

Size W x D x H mm	Suitable for	Shelves number	Code ESD
455 x 200 x 290	AKV	3	EPL12 ESD

Rack with three fixed shelves. Bins ordered separately, page 50. Component rack holds: 12 stacking bins 1015-4ESD or 12 picking bins 30-1L-4ESD or 6 picking bins 30-2L-4ESD or 6 picking bins 30-23L-4ESD.



Component rack EPL

**Document stand WDA**

Size W x H mm	Suitable for	Code	Code ESD
440 x 300	AL2X upright profiles	WDA	WDA ESD

Document stand A3 with swivel arm. Epoxy powder coated steel: light grey. Arm length 220 mm. Tilt 75°.



Document stand WDA

**Perforated panel ARL**

Size W x H mm	Suitable for	Code	Code ESD
668 x 500	AKK70, AKK150	ARL70	ARL70
968 x 500	AKK180, AL2X110 W/QX	ARL100	ARL100

Mount on accessory frame AKK. The size of the perforation is 9 x 9 mm, center to center 38 mm.

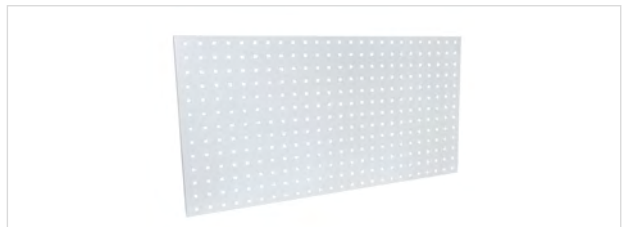

Perforated panel ARL

**Bin profile BP**

Length mm	Suitable for	Code	Code ESD
685	AKK 70, AKK150, AKK180	BP70	BP70 ESD
985	AKK180, AL2X110 W/QX	BP100	BP100 ESD

Aluminium profile for stacking and picking bins. Mount on accessory frame AKK.



Bin profile BP

**Auxiliary steel shelf for perforated panel**

Size W x D x H mm	Suitable for	Code
159 x 243 x 56	Perforated panel ARL	ASSA5PP

Auxiliary steel shelf for A5 documents, tape dispenser or handheld scanner. Attached to the perforated panel.



Auxiliary steel shelf for perforated panel



Auxiliary steel shelf for bin profile

**Auxiliary steel shelf for bin rail**

Size W x D x H mm	Suitable for	Code
217 x 330 x 50	BP	ASSA4
159 x 254 x 50	BP	ASSA5

Shelf for A4/A5 paper and tape dispensers (max 2 pcs per shelf). Mounted on bin profile. Max load 3 kg.

**Tool holder box PPH**

Size W x D x H mm	Suitable for	Code
400 x 300 x 140	WB, TP, TPH, Concept Ergo, Concept, TPB, TED	PPH TXL

PPH TXL with two blue plastic bins type 3020.



Tool holder box PPH

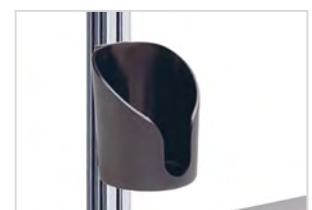

Bottle holder CH

**Bottle holder CH**

Size W x D x H mm	Ø mm	Suitable for	Code
110 x 105 x 120	80	AL2X upright profiles	CH

Practical holder for bottle or cup. Made of black polypropylene.

**Recycling material bin PRMB**

Size W x D x H mm	Suitable for	Code
282 x 590 x 600	WB, TP, TPH, TPB, TED	PRMB
The 60 ltr bin with steel brackets has a maximum load of 15 kg and can be positioned on either side of the bench.		
286 x 590 x 650	WB, Concept Ergo, Concept, TP, TPH, TPB	PRMB3
This pull-out model with steel rails is fixed under the worktop. Bin 60 ltr. Max load 15 kg.		
286 x 590 x 600	QuatreX	PRMBQX
The 60 ltr bin with steel brackets has a maximum load of 15 kg and can be positioned on either side of the bench.		



PRMB



PRMB3



PRMBQX

**Recycling material bins**

**Tool tray PTH**

Size W x D mm	Suitable for	Code
1000 x 60	WB, QuatreX, TED, Concept Ergo	PTH100
The tool tray guarantees a clean working space, while tools are close to hand.		



Tool tray PTH

**Cable clip set CC**

Set	Suitable for	Code	Code ESD
5 pieces	AL2X upright profiles	CC8	CC8
The cable clip set will hold cables etc. securely and neatly in place along the bench frame. The clips locate in the 8 mm profile slot.			



Cable clip set CC

**Power rails**

Description	Length	Code
3 sockets + 2 x USB	331	TPR3-001
6 sockets + switch + 2 x USB	468	TPR4-001
6 sockets + switch + 2 x USB + 2 x CAT6A	468	TPR4-003
4 sockets + switch + fault current protection	468	TPR4-004
6 sockets + switch	468	TPR4-005
5 sockets + switch + 2 x USB	683	TPR7-001
5 sockets + switch + 2 x USB + 2 x CAT6A	683	TPR7-003
4 sockets + switch + fault current protection + 2 x USB	683	TPR7-008
10 sockets + switch	683	TPR7-038
6 sockets + switch + 2 x USB	836	TPR9-001
6 sockets + switch + 2 x USB + 2 x CAT6A	836	TPR9-003
6 sockets + switch + fault current protection + 2 x USB	836	TPR9-010
12 sockets + switch	836	TPR9-276
6 sockets + switch + 2 x USB	1400	TPR14-001
6 sockets + switch + fault current protection + 2 x USB	1400	TPR14-010
6 sockets + switch + 2 x USB	1700	TPR17-001
6 sockets + switch + fault current protection + 2 x USB	1700	TPR17-010

More information and images on power rails on page 94.



Power rails

**Holder for Thin Client PC**

Size W x D x H mm	Max load kg	Code
250 x 45-65 x 145	5	TCH
Mounted to aluminium upright profile.		



Holder for Thin Client PC

**PC stand CPU**

Width mm	Height mm	Suitable for	Code
130-240	395-500	WB, QuatreX, TED, TP, TPH, Concept handcrank (depth 750/900 mm), SAP, WTR and Concept trolleys	CPU
340-460	180-285		

An adjustable holder for either vertical or horizontal CPU, to mount underneath the table worktop.



PC stand CPU

**LCD bracket MH**

Max load kg	Suitable for	Code
15	AL2X upright profiles	MH

The quick-release mechanism is equipped with the standard used flat-screen mount 75 x 75 and 100 x 100 for the mounting of all normal flat-screens.



LCD bracket MH



LCD swivel arm MA

**LCD swivel arm MA**

Max load kg	Suitable for	Code
10	AL2X upright profiles	MA

The quick-release mechanism is equipped with the standard flat-screen mount 75 x 75 and 100 x 100 for the mounting of all normal flat-screens. The arm is double articulated, turns through a radius of 180° and will extend between 95-425 mm from the upright.



LCD swivel arm MA2

**LCD swivel arm MA2**

Max load kg	Suitable for	Code
15	AL2X upright profiles	MA2

The quick-release mechanism is equipped with the standard, widely used flat-screen mount 75 x 75 and 100 x 100 for the mounting of all normal flat-screens. The arm is double articulated, turns through a radius of 180° and will extend between 95-425 mm from the upright.



LCD screen holder MA4

**LCD screen holder with height adjustable arm MA4**

Max load kg	Suitable for	Code
2-7 kg	AL2X upright profiles	MA4

Highly ergonomic and easily height adjustable monitor arm with a gas spring. Easy mounting of the monitor with a quick-release mechanism, standard flat screen mount 75 x 75 mm and 100 x 100 mm for LCD screens. Cable management by cable clips. The double arm turns through a radius of 180 and will extend between 80-500 mm from the upright.



LCD bracket MH + tablet bracket MY

**Tablet bracket MY**

Suitable for	Code
Requires either an MH, MA, MA2 or MA4 swivel arm.	MY

For 7-10" tablets.

**Arm adapters for Concept Ergo, Concept, QuatreX, TED, Quick Edge, TP and Heavy duty accessories with arms**

Profile type	Workbench / trolley model	40 mm arm	60 mm arm
C-profiles	TPH, TPB	-	E824 081-49
AL2X aluminium profiles	WB, QuatreX	890 524-49	890 525-49
Aluminium profiles	WTR	E821 573-49	E821 572-49

Arm accessories for upright tubes can be used in other profile types with adapters.



# Accessories for TPH and TPB

## Tool and lighting support KT

	Size W x D mm	Suitable for	Code	Code ESD
	1200 x 600	TPH712	KT120	KT120
	1500 x 600	TPH715/915 and TPB915	KT150	KT150
	1800 x 600	TPH718/918 and TPB918	KT180	KT180
Extra C-profile	1500	KT150	SPR150	SPR150
Extra C-profile	1800	KT180	SPR180	SPR180

For suspending power tools and lighting units. Includes one C-profile bar with sliding hook.



Tool and lighting support KT

## High upright profile pair HKCP

Height mm	Suitable for	Code	Code ESD
1470	TPH/TPB	HKCP147	HKCP147

High upright profile pair provides more space for TPH accessories



High upright profile pair HKCP

## Cable tidy TPHCT

Size W x D x H mm	Suitable for	Code	Code ESD
1115 x 45 x 205	TPH712	TPHCT120	TPHCT120
1415 x 45 x 205	TPH715/915	TPHCT150	TPHCT150
1715 x 45 x 205	TPH718/918	TPHCT180	TPHCT180

Mounted between C-profiles below worktop. Of perforated epoxy powder coated steel.



Cable tidy TPHCT

## Metal shelf TH

Size W x D mm	Max load kg	Suitable for	Code	Code ESD
1119 x 145	30	TPH712	TH120	TH120 ESD
1419 x 145	30	TPH715/915, TPB915	TH150	TH150 ESD
1719 x 145	30	TPH718/918, TPB918	TH180	TH180 ESD

Adjustment for depth, height and angle. For stacking and picking bins. Load capacity 30 kg.



Metal shelf TH

## Auxiliary shelf SH

Size W x D mm	Max load kg	Suitable for	Code	Code ESD
1200 x 310	50	TPH712	SH120	SH120 ESD
1500 x 310	50	TPH715/915	SH150	SH150 ESD
1800 x 310	50	TPH718/918	SH180	SH180 ESD

Height adjustable shelf. 25 mm laminated chipboard.



Auxiliary shelf SH

## Divider hoops PDH

Height mm	Suitable for	Code	Code ESD
400	SH shelf	PDH	PDH

Used in combination with shelf SH. Comes in sets of 5.



Divider hoops PDH

**Backstop LIST**

Size W x D x H mm	Suitable for	Code ESD
1400 x 52 x 27	AT 150TPH, SH150	LIST150
1700 x 52 x 27	AT 180TPH, SH180	LIST180

Prevents items from falling off the shelf.

**Bin profile BP**

Width mm	Max load kg	Suitable for	Code	Code ESD
profile 1115	15	TPH712	BP120	BP120 ESD
profile 1415	15	TPH715/915, TPB915	BP150	BP150 ESD
profile 1715	15	TPH718/918, TPB918	BP180	BP180 ESD

Aluminium profile for stacking and picking bins.

**Auxiliary steel shelf for bin profile**

Size W x D x H mm	Suitable for	Code
217 x 330 x 50	BP	ASSA4
159 x 254 x 50	BP	ASSA5

Shelf for A4/A5 paper and tape dispensers (max 2 pcs per shelf). Mounted on bin profile. Max load 3 kg.

**Stacking bin set SBS4**

Size W x D x H mm	Suitable for	Code
2 pcs 230 x 155 x 140 2 pcs 185 x 125 x 115	BP	SBS4

Four bins made of blue polypropylene (PP).

**Swivel arm with tray CKV**

Size W x D mm	Max load kg	Suitable for	Code	Code ESD
Tray 460 x 210	15	TPH/TPB	CKV400	CKV400 ESD

Angle adjustable steel tray with swivel radius of 360°. Max. load 15 kg.

**Component rack EPL**

Size W x D x H mm	Suitable for	Shelves number	Code ESD
455 x 200 x 290	CKV	3	EPL12 ESD

Rack with three fixed shelves. Of semiconductive epoxy powder coated steel in light grey (RAL 7035).



Backstop LIST



Bin profile BP



Auxiliary steel shelf ASSA



Stacking bin set SBS4

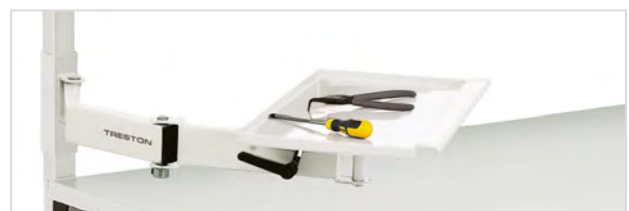

Swivel arm with tray CKV



Component rack EPL, swivel arm with tray CKV and bins

**Perforated panel RL**

Size W x H mm	Suitable for	Code	Code ESD
1115 x 750	TPH712	RL120	RL120
1415 x 750	TPH715/ 915	RL150	RL150
1715 x 750	TPH718/ 918	RL180	RL180
Connector set for RL perforated panels	TPH	RK1	RK1

Robust, perforated steel panel. 9 mm perforations at 38 mm centres. Mount on TPH-benches with connectors RK 1. Can also be attached to a wall with screws (included).

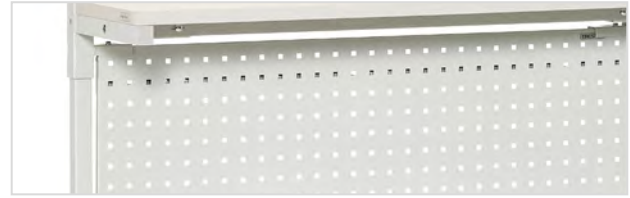

**Perforated panel RL**

**Auxiliary steel shelf for perforated panel**

Size W x D x H mm	Suitable for	Code
159 x 243 x 56	Perforated panel RL	ASSA5PP

Auxiliary steel shelf for A5 documents, tape dispenser or handheld scanner. Attached to the perforated panel.



**Auxiliary steel shelf for perforated panel**

**Tool holder box PPH**

Size W x D x H mm	Suitable for	Code
400 x 300 x 140	All benches	PPH TXL

PPH TXL with two blue plastic bins type 3020.



**Tool holder box PPH**

**Recycling material bin PRMB**

Size W x D x H mm	Suitable for	Code
282 x 590 x 600	WB, TP, TPH, TPB, TED benches	PRMB

The 60 ltr bin with steel brackets has a maximum load of 15 kg and can be positioned on either side or rear of the bench.



**Recycling material bin PRMB**

**Recycling material bin PRMB3**

**Recycling material bin PRMB3**

Size W x D x H mm	Suitable for	Code
286 x 590 x 650	WB, Concept, TP, TPH and TPB	PRMB3

This pull-out model with steel rails is fixed under the worktop. Bin 60 ltr. Max load 15 kg.

**Pull-out steel shelf for printer**

Size W x D x H mm	Max load kg	Suitable for	Code
500 x 510 x 515	35	Concept, TPB	PSP50

Suitable for 750 and 900 deep Concept benches.



**Pull-out steel shelf for printer**

**CPU holder**

Size W x D x H mm	Max load kg	Suitable for	Code
180-225 x 450 x 50	20	TP/TPH	854 440-49

**Cable clip set CC**

Set	Max load kg	Suitable for	Code	Code ESD
5 pcs/set	15	TPH/TPB	CC12	CC 12

The cable clip set will hold cables etc. securely and neatly in place along the bench frame. The clips locate in the 12 mm profile slot.



**CPU holder**



**Cable clip set CC**

**LCD bracket MH**

Max load kg	Suitable for	Code
1.5	TPH/TPB+ AS2	MH

The quick-release mechanism is equipped with the standard used flat-screen mount 75 x 75 and 100 x 100 for the mounting of all normal flat-screens. **Adapter set AS2 is needed for mounting LCD bracket MH to TPH benches, ordered separately.**



LCD bracket MH

**LCD swivel arm MA**

Max load kg	Suitable for	Code
1.0	TPH/TPB+ AS2	MA

The quick-release mechanism is equipped with the standard flat-screen mount 75 x 75 and 100 x 100 for the mounting of all normal flat-screens. The arm is double articulated, turns through a radius of 180° and will extend between 95-425 mm from the upright. **Adapter set AS2 is needed for mounting LCD swivel arm MA to TPH benches, ordered separately.**



LCD swivel arm MA

**LCD swivel arm MA2**

Max load kg	Suitable for	Code
1.5	TPH/TPB+ AS2	MA2

The quick-release mechanism is equipped with the standard, widely used flat-screen mount 75 x 75 and 100 x 100 for the mounting of all normal flatscreens. The arm is double articulated, turns through a radius of 180° and will extend between 95-425 mm from the upright. **Adapter set AS2 is needed for mounting LCD swivel arm MA2 to TPH benches, ordered separately.**



LCD swivel arm MA2

**LCD screen holder with height adjustable arm MA4**

Max load kg	Suitable for	Code
2-7	TPH/TPB + AS4C	MA4

Highly ergonomic and easily height adjustable monitor arm with a gas spring. Easy mounting of the monitor with a quick-release mechanism, standard flat screen mount 75 x 75 and 100 x 100 for LCD screens. Cable management by cable clips. The double arm turns through a radius of 180 and will extend between 80-500 mm from the upright. **Adapter AS4C is needed for mounting LCD swivel arm MA4 to TPH/TPB benches, ordered separately.**



LCD screen holder MA4

**Adapter set AS**

Suitable for	Code
MH / MA / MA2	AS2
MA4	AS4C

**The above adapter sets / adapters are needed for fixing MH/MA/MA2/MA4 arms to the TPH/TPB C-profiles**



Adapter set AS2



Adapter AS4C

**Tablet bracket MY**

Suitable for	Code
Requires either an MH, MA, MA2 or MA4 swivel arm.	MY

For 7-10" tablets.



LCD bracket MH + tablet bracket MY

**Power rails**

Description	Length	Code
3 sockets + 2 x USB	331	TPR3-001
6 sockets + switch + 2 x USB	468	TPR4-001
6 sockets + switch + 2 x USB + 2 x CAT6A	468	TPR4-003
4 sockets + switch + fault current protection	468	TPR4-004
6 sockets + switch	468	TPR4-005
5 sockets + switch + 2 x USB	683	TPR7-001
5 sockets + switch + 2 x USB + 2 x CAT6A	683	TPR7-003
4 sockets + switch + fault current protection + 2 x USB	683	TPR7-008
10 sockets + switch	683	TPR7-038
6 sockets + switch + 2 x USB	836	TPR9-001
6 sockets + switch + 2 x USB + 2 x CAT6A	836	TPR9-003
6 sockets + switch + fault current protection + 2 x USB	836	TPR9-010
12 sockets + switch	836	TPR9-276
6 sockets + switch + 2 x USB	1400	TPR14-001
6 sockets + switch + fault current protection + 2 x USB	1400	TPR14-010
6 sockets + switch + 2 x USB	1700	TPR17-001
6 sockets + switch + fault current protection + 2 x USB	1700	TPR17-010

More information and images on power rails on page 98.



Power rails

**Shelf for packing material SPM**

Size W x D x H mm	Max load kg	Code
467 x 600 x 32	60	SPM500-49
717 x 600 x 32	60	SPM750-49
870 x 600 x 32	60	SPM900-49
1167 x 600 x 32	60	SPM1200-49
1317 x 600 x 32	60	SPM1350-49
1467 x 600 x 32	60	SPM1500-49
1773 x 600 x 32	60	SPM1800-49

The shelf does not include fastening parts.



Shelf for packing material, adjustable fastening set under worktop and divider hoops

**Adjustable fastening set under worktop**

Size W x D x H mm	Suitable for	Code
90 x 350 x 355	SPM-shelves	SPMAF-49

Free space 285-465 mm on lower shelf.



Adjustable fastening set under worktop

**Divider hoops set (4 pcs)**

Size W x D x H mm	Suitable for	Code
8 x 400 x 280	SPM-shelves	PDH600-49

**Fixed tape dispenser**

Name	Suitable for	Code
Fixed tape dispenser	All benches	FTD50

Includes screws to fix the dispenser to ASSA4. Max roll Ø 120 mm and width 50 mm.



Fixed tape dispenser



Basic label dispenser

**Basic label dispenser**

Size W x D x H mm	Suitable for	Code
214 x 128 x 120	All benches	BLD20

Can be fixed with screws. Max roll Ø 220 mm and width 210 mm.

Additional packing accessories on page 78.

# Accessories that suit all benches

*Note! Not suitable for Quick Edge*

## Equipment tray with bench top fixing

Size W x D x H mm	Max load kg	Suitable for	Code
250 x 250 x 90	5	all benches	860 885-49



Equipment tray

## Document holder A4 with bench top fixing

Size W x D x H mm	Max load kg	Suitable for	Code
290 x 330	5	all benches	860 882-49



Document holder

## Tool panel with bench top fixing

Size W x D x H mm	Max load kg	Suitable for	Code
267 x 305	5	all benches	860 883-49



Tool panel



Bin rail

## Bin rail with bench top fixing

Size W x D x H mm	Max load kg	Suitable for	Code
315 x 72	5	all benches	860 884-49

## Light arm, bench top fixing

Size W x D x H mm	Max load kg	Suitable for	Code
200	5	all benches	860 990-49



Light arm



Bag holder

## Bag holder for bench lower edge

Size W x D x H mm	Suitable for	Code
16 x 60 x 37	all benches	860 840-49

## Keyboard tray NT

Size W x D x H mm	Suitable for	Code
525 x 399 x 133 (outer), 500 x 250 x 110 (inner)	WB, TP, TPH benches, Treston PoweX Move, SAP/WTR trolleys	NT 500 ESD



Keyboard tray NT



Keyboard tray (attached to the bench top)

## Keyboard tray (attached to the bench top)

Size W x D x H mm	Max load kg	Suitable for	Code
680 x 375 x 106 (outer) 620 x 305 x 90 (inner)	10	Concept Ergo, TP, TPH, WB and heavy duty benches	925 49 001P

# Footrests

## Footrest, floor

Size W x D mm	Height	Tilting	Suitable for	Code ESD
550 x 350	100	5-30°	All benches	860 947-49



Footrest, floor

## Footrest, floor, height adjustable

Size W x D mm	Height	Tilting	Suitable for	Code ESD
550 x 350	90-280	5-30°	All benches	860 137-49

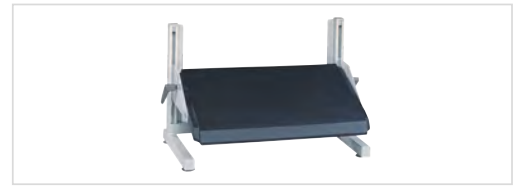

Footrest, floor, height adjustable

## Footrest, floor, with gas action

Size W x D mm	Height	Tilting	Suitable for	Code ESD
550 x 350	90-260	5-30°	All benches	860 224-49



Footrest, floor, with gas action



Bar fixed footrests for Concept Ergo on page 29.

# ESD accessories



Earthing box



Earth junction box, yellow



Earthing cable, black



Earthing cable

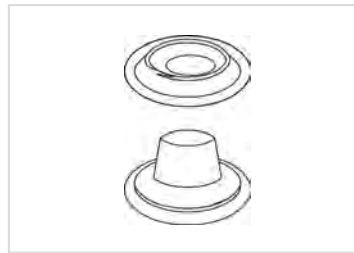

Press stud



Common point ground rail

## Earthing supplies

Name	Press button	Resistance	Code ESD
Earthing box	3 x 10 mm	1 Mohm	J6603
Earth junction box, yellow. Cable 2 m.			860 522-00
Earthing cable, black, 1,5 m	10 mm / M5 terminal	1 Mohm	860 520-00
Earthing cable 5 m	10 mm		MK3040
Press stud	10 mm / female		PN3034
Common point ground rail			860 530-00

## Wrist straps

Name	Press button	Resistance	Code ESD
Adjustable wrist strap	7 mm	1 Mohm	R2216
Metal wrist strap	7 mm	1 Mohm	R2206

Wrist strap set includes wrist band and coiled cord. Earth lead with 1 megaohm resistor, length 3,6 m. Includes 7 mm press stud for connection to wrist strap and 10 mm press stud for connection to earthing point.



Adjustable wrist strap



Metal wrist strap

## ESD mats

Name	Size W x D mm	Code ESD
ESD Ergo floor mat	950 x 650	852 880-00
ESD bench top mat*	1,22 x 10,00 m (12,20 m <sup>2</sup> )	PM157

\*Resistant to heat, solder flux, most chemicals and solvents. The ESD mats are to EN 61340-5-1 standards. Abraded non slip underside. Does not contain PVC. Supplied by the metre or in rolls. Colour: platinum grey. Resistance surface to ground:  $7,5 \times 10^5 - 10^7$  ohm.



ESD Ergo floor mat



ESD bench top mat

# Treston power rails

Treston power rails include USB-charging (A+C) and also fault current protection is available in most of the standard rail lengths available from stock. Stock selection also includes three lengths with 2 x CAT6A data connectors. Also versions with other data and audio connectors and customised combinations of these are available on request.

Power rails come with brackets for fixing to Treston workstations. Rails can be fixed vertically on upright or aluminum profile, horizontally on aluminum profile or on M750 and M900 modules between uprights. With the new bracket set rails can also be fixed straight to the table top or perforated panel. A power rail can be mounted to four different angle on brackets. Length of rail can limit the mounting possibilities.



## Ideal mounting for different lengths

Code	Length	Concept Ergo, Concept, QuatreX, TP and industrial workbenches uprights	WB and QuatreX aluminium profile	TPH	TED
TPR3-	331	Vertical	Hor/Ver	On table top	Upright vertical
TPR4-	468	Vertical	Hor/Ver	On table top	On table top
TPR7-	683	M750 horizontal	Hor/Ver	On table top	M750
TPR9-	836	M900 horizontal	Hor/Ver	On table top	M900
TPR14-	1400	On table top	On table top	On table top	On table top
TPR17-	1700	On table top	On table top	On table top	On table top

## Power rails

Description	Length	Code
1 3 sockets + 2 x USB	331	TPR3-001
2 6 sockets + switch + 2 x USB	468	TPR4-001
3 6 sockets + switch + 2 x USB + 2 x CAT6A	468	TPR4-003
4 4 sockets + switch + fault current protection	468	TPR4-004
5 6 sockets + switch	468	TPR4-005
6 5 sockets + switch + 2 x USB	683	TPR7-001
7 5 sockets + switch + 2 x USB + 2 x CAT6A	683	TPR7-003
8 4 sockets + switch + fault current protection + 2 x USB	683	TPR7-008
9 10 sockets + switch	683	TPR7-038
10 6 sockets + switch + 2 x USB	836	TPR9-001
11 6 sockets + switch + 2 x USB + 2 x CAT6A	836	TPR9-003
12 6 sockets + switch + fault current protection + 2 x USB	836	TPR9-010
13 12 sockets + switch	836	TPR9-276
14 6 sockets + switch + 2 x USB	1400	TPR14-001
15 6 sockets + switch + fault current protection + 2 x USB	1400	TPR14-010
14 6 sockets + switch + 2 x USB	1700	TPR17-001
15 6 sockets + switch + fault current protection + 2 x USB	1700	TPR17-010



# Packing material roll stands and cutters

## High packing material roll stand

Size W x D x H mm	Module	Max roll width mm	Code
1380 x 764 x 1640	M1350	1200	890 520-49P
1530 x 764 x 1640	M1500	1400	890 521-49P
1830 x 764 x 1640	M1800	1700	890 522-49P

High stand for two rolls. The rolls are adjustable in height. Axle diameter 25 mm. Max roll Ø 800 mm. Can be equipped with extra roll holder set, castor set and cutter PPC. Max load 40 kg per roll.



High packing material roll stand

## Low packing material roll stand

Size W x D x H mm	Module	Max roll width mm	Code
1380 x 764 x 1000	M1350	1200	859 103-49P
1530 x 764 x 1000	M1500	1400	859 105-49P
1830 x 764 x 1000	M1800	1700	859 108-49P

Low stand for one roll. The roll is adjustable in height. Axle diameter 25 mm. Max roll Ø 800 mm. Can be equipped with extra roll holder set, castor set and cutter PPC. Max load 40 kg per roll.



Low packing material roll stand

## Castor set for packing material roll stands

Size mm	Code
Ø 100	LCS100

4 swivel castors Ø 100 mm, 2 with brakes. Attached directly to the stands.



Castor set for packing material roll stands

## Extra roll holder set

Module	Max roll width mm	Code
M1350	1200	859 040-49P
M1500	1400	859 041-49P
M1800	1700	859 042-49P

Extra roll holder set for packing material roll stands. Including brackets. Axle diameter 25 mm, zinc electroplated. Max load 40 kg.



Extra roll holder set

**Cutter PPC**

Size W x D x H mm	Module	Cutting width mm	Code
1200 x 130 x 200	M1200	950	PPC120
1350 x 130 x 200	M1350	1110	PPC135
1485 x 130 x 200	M1500	1250	PPC150
1785 x 130 x 200	M1800	1550	PPC180

The round cutting knife will slice through paper and cardboard with ease. Can be affixed to the bench top or alternatively to the upright profiles with fixing brackets PPC FB.



Cutter PPC

**Fixing brackets for cutter**

Suitability	Code
All benches	PPC FB

In order to obtain an ergonomic position, the cutters can also be affixed to the upright profiles of all the workbenches using these fixing brackets. The fixing brackets make the cutter both height and tilt adjustable, tilt 30 degrees. Cutter is ordered separately.



Fixing brackets for cutter

**Bracket pair for cutter**

Suitability	Code
Packing material roll stands	890 511-49P

Cutter PPC can be fitted to the packing material roll stand with the bracket pair. Height adjustable. Cutter is ordered separately.



Bracket pair for cutter



A woman with brown hair and bangs, wearing a red polo shirt, is smiling and holding a long, rectangular, illuminated light fixture. The fixture has the brand name 'TRESTON' printed on its top surface. In the background, there are other similar light fixtures mounted on a white wall. One fixture is partially visible on the left, showing a world map graphic on its side. Another fixture is mounted on the ceiling. A white rectangular box with a red vertical bar on its left side is positioned in the upper right area of the image, containing the section title.

## 3. Lighting

TRESTON

TRE

# Lighting ergonomics



Lighting is a vital part of ergonomic workspaces in industrial environments. Light allows people to see and perform tasks better and it affects their personal wellbeing and health.

## Individually adjustable, natural workstation lighting means more productivity

Investing in individually controllable task lighting on workstations benefits both the employees and the employer. Employees feel more motivated as they can adjust brightness and preferably also colour tone to best suit themselves and the task at hand. This can lead to increased productivity, reduced errors and less absence, which normally affect the company's profitability.

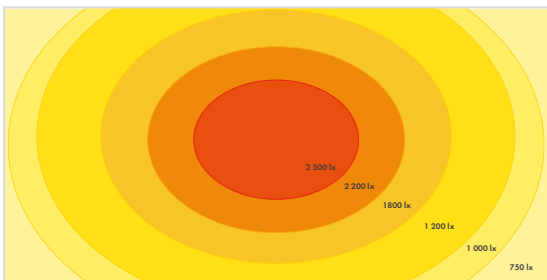

**Graph of light Illuminance**

Treston NaturLite LED 1200 Illuminance  $\pm 10\%$  (@1 meter)

## Lighting standard sets the expectations

When designing workstations and their lighting, we observe the recommendations of the EN 124641 standard on indoor workplace lighting. The illuminance levels set by standards are average values, but going beyond those is often reasonable. It is especially beneficial to increase the high-quality lighting for employees over 45 years old.

## Optical ergonomics need attention

Optical ergonomics require the viewed object to be at a suitable distance and location, in order to maintain an acceptable amount of eye movement and ensure that the details can be seen without problems. Also, adequate and glare-free lighting is important. When these conditions apply and the working position is well adjusted, saving time and money due to fewer absences and decreased stress can be expected.

## Benefits of proper adjustable lighting in industrial environments include

- Reduced number of errors
- Decreased absenteeism
- Increased well-being of the employees
- Increased productivity

# Treston NaturLite LED: Natural workstation lighting for industrial environments



Good, adjustable workstation lighting is essential for work quality and the well-being of employees. The right amount of light at the right time also enhances productivity and reduces errors in industrial environments.

**Achieve your full potential with:**

- Tunable colour tone
- Dimmable brightness
- Effective performance



Get all the specifications  
and download the brochure



[treston.com/catalogues-and-brochures](https://treston.com/catalogues-and-brochures)

## Treston NaturLite LED Plus 1200

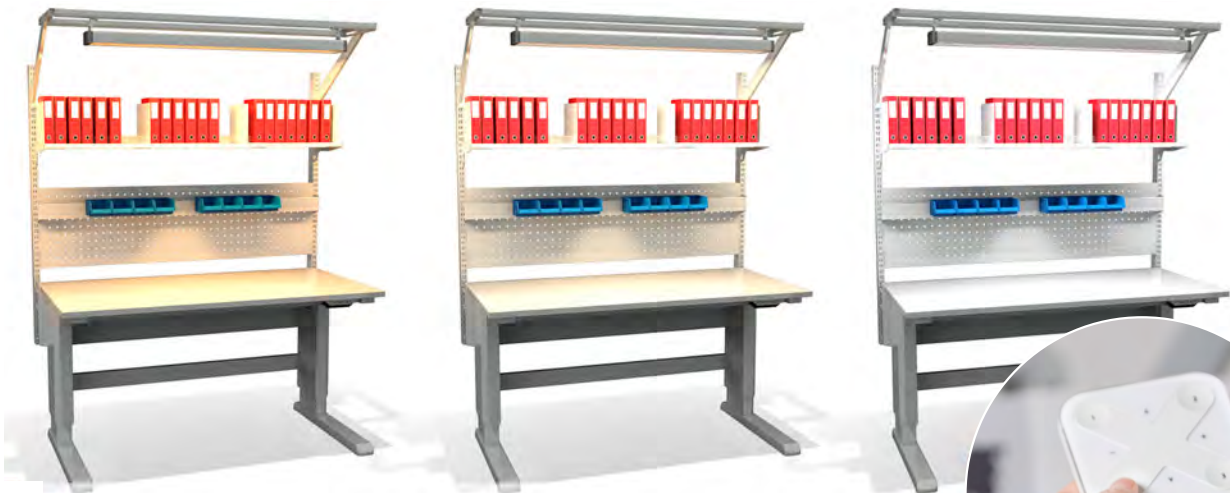

Adjusting colour temperature can have a positive effect on employee productivity and well-being. Beneficial also in environments where it is important to see objects in different light ranges.

Convenient to use with  
a mobile app or a remote control.



**Treston NaturLite LED Plus 1200**  
Light with tunable colour tone



**Treston NaturLite LED 900**  
Dimmable light for smaller tables



**Treston NaturLite LED 1200**  
Dimmable light for wider tables



**Treston NaturLite LED Wing 500**  
Versatile task light with dimming

Name	Control	Colour temperature	Illuminance ±10% (@1 meter)	Luminous flux	Power	Size W x D x H mm	Suitability	Code
1. <b>Treston NaturLite LED Plus 1200</b>	Controlled via mobile app or separate remote control + ON/OFF button in the luminaire body	2700 - 6500 K	@4000 K: 2800 lx (1000 - 2800 lx depending on the colour temperature)	3200-6300 lm (depending on the selected colour temperature)	60 W	1180 x 120 x 50	All Treston and various other industrial workbenches	TNL1200P
<b>Remote control for Treston NaturLite LED Plus 1200</b>	Easy to use and save presets via mobile app. White.					90 x 90 x 12	Treston NaturLite LED Plus 1200	TNLPR
2. <b>Treston NaturLite LED 1200</b>	Touch dim button switch for ON/OFF and dimming in the luminaire body	4000 K	3100 lx	7100 lm	56 W	1180 x 120 x 50	All Treston and various other industrial workbenches	TNL1200
3. <b>Treston NaturLite LED 900</b>	Touch dim button switch for ON/OFF and dimming in the luminaire body	4000 K	2300 lx	5200 lm	42 W	900 x 120 x 50	All Treston and various other industrial workbenches	TNL900
4. <b>Treston NaturLite LED Wing 500</b>	Touch dim button switch for ON/OFF and dimming in the luminaire body	4000 K	800 lx	1750 lm	14 W	430 x 120 x 50 mm (+ bracket 95/120 mm)	Concept Ergo, Concept, WB, QuatreX, TED, TP, TPH and TPB benches* Treston Tower	TNL500W

**Common features:** Dimmable, Lifetime > 50 000 hours (L90B10), Color Rendering Index CRI > 80, High quality LED (MacAdams < 3) Aluminium body, 2 years guarantee, Enclosure protection IP20

\* TPH and TPB benches require bracket 890 683-49



Watch this [animation](#) and get the main facts of the Treston NaturLite LED lights in less than 2 minutes.

# Cutting edge technology

- Tunable colour tone (2700-6500 K)
- Power 14-60 W (max)
- Illuminance 800-3100 lx  $\pm$ 10 % (1 meter)
- Lifetime > 50 000 hours (L90B10)
- Color Rendering Index CRI > 80
- High quality LED (MacAdams < 3)
- Dimmable 1/10-100%
- Lean design
- 2 years guarantee
- Suitable for all Treston and various other industrial workbenches
- Enclosure protection IP20



- ✓ Adjustability helps to find optimal lighting conditions.
- ✓ Timeless design brings functional beauty to industrial environments and it is never out of style.
- ✓ Easy and fast to install – just click, slide and screw.
- ✓ High-quality LED lights with high-quality drivers are care-free for years to come. Low maintenance, just keep them clean!
- ✓ Designed and manufactured in Finland.



## Treston NaturLite LED Wing 500

- Versatile task light
- Working area with or without shadows
- Also suitable in the middle of the table

# Optimal light for industrial environments: Treston IntoLite LED



- ✓ Good quality, bright and long lasting light.
- ✓ Light with basic features and capability to give optimal light to workstation.

Name	Control	Colour temperature	Illuminance ±10% (@1 meter)	Luminous flux	Power	Size W x D x H mm	Suitability	Code
<b>Treston IntoLite LED</b>	Touch button switch for ON/OFF	4000K	1800 lux ±10%	3800 lm	36W	850 x 67 x 80	All Treston and various other industrial workbenches	TIL850

**Common features:** Lifetime > 50 000 hours (L70B10), 2 years guarantee, Enclosure protection IP20

## Compatibility with light and balancer rails

	Module / suitable for	Front profile width mm	Code	Compatible lighting units
Light and balancer rail (Concept Ergo, Concept, QuatreX, TED, Quick Edge, TP and industrial workbenches)	2 x M500	1000	91849001P	TNL900, TIL850
	2 x M500/1500	1500	91849002P	TNL900, TNL1200, TNL1200P, TIL850
	4 x M500	2000	91849003P	TNL900, TNL1200, TNL1200P, TIL850
	M750	750	91849004P	-
	M750/900	900	91849013P	TNL900, TIL850
	M750/1500	1500	91849005P	TNL900, TNL1200, TNL1200P, TIL850
	2 x M750	1500	91849006P	TNL900, TNL1200, TNL1200P, TIL850
	3 x M750	2250	91849012P	TNL900, TNL1200, TNL1200P, TIL850
	M900	900	91849007P	TNL900, TIL850
	2 x M900	1800	91849008P	TNL900, TNL1200, TNL1200P, TIL850
	M900/1500	1500	91849009P	TNL900, TNL1200, TNL1200P, TIL850
	M1200	1200	91849010P	TNL900, TNL1200, TNL1200P, TIL850
	M1350	1350	91849011P	TNL900, TNL1200, TNL1200P, TIL850
Support bracket HSB (WB and QuatreX benches)	AL2X110 W/QX	1073	HSB110	TNL900, TIL850
	AL2X150 W/QX	1500	HSB150	TNL900, TNL1200, TNL1200P, TIL850
	AL2X180 W/QX	1800	HSB180	TNL900, TNL1200, TNL1200P, TIL850
Tool and lighting support KT (TPH and TPB benches)	TPH712	1200	KT120	TNL900, TNL1200, TNL1200P, TIL850
	TPH715/915, TPB915	1500	KT150	TNL900, TNL1200, TNL1200P, TIL850
	TPH718/918, TPB918	1800	KT180	TNL900, TNL1200, TNL1200P, TIL850

# Magnifying lamp

## Treston Wave LED ESD



- ✓ Lamp can be easily adjusted to desired position thanks to very precise and flexible 3-joint arm.
- ✓ Lamp offers shadow-free magnification with light coming from both sides.
- ✓ Wave LED ESD is suitable for use in EPA-areas.
- ✓ Suitable for all Treston Workbenches and other manufacturers' workbenches

Name	Control	Colour temperature	Illuminance ±10% (@1 meter)	Luminous flux	Power	Size W x D x H mm	Fixing	Code
<b>Treston Wave LED ESD</b>	2-sided touch button with 4 level dimming	4000K	1500 lx	764 lm	13W	Lamp 227 x 225 x 40 mm, 3-joint arm length 500 + 550 mm	Table clamp (max thickness 72 mm)	TWL ESD

**Common features:** Lifetime > 50 000 hours, 5 years guarantee, Enclosure protection IP20. Power cord 1,7m with Schuko-plug CEE7/7.



## 4. Chairs

# High-performance industrial chairs



Treston chair range offers high-performance seating solutions with maximum customer benefit for any industrial and technical working environment. Our high-quality technical products fulfill the highest requirements, offer outstanding value for money and meet the requirements of various workplaces – from production and packaging to standing work, ESD areas and R&D environments.

## Industrial workplaces require industrial chairs

An ergonomically sound chair is a vital part of the well-functioning, ergonomic and user-friendly workstation. Good sitting enables effective and appropriate movements, reduces postural fixity and enables good and relaxed working postures. The ergonomic requirements of workplace chairs in industrial and technical environments are inherently different to those of other areas, such as office. The jobs carried out at manufacturing workstations may involve force, precision skills and repetitive movements, and thus the workplace chair must adapt perfectly to these tasks and working environments in order to support the workers – and their well-being- in the best possible way.

## Six models with 24 variations

The chair range consists of six different models: Multi-purpose Treston Ergo, Treston Plus with an all-inclusive ergonomic package, new generation workplace chair Neon with changeable upholsteries, Flex for standing work, Stool for assistance in workshops and Saddle chair for alternative way of sitting. In addition, there are three surfaces/upholsteries to choose from: a highly resistant polyurethane, comfortable fabric and easy-to-care artificial leather, making it is easy to find the most suitable chair for the working environment from our 24 chair variations.

## Safe, sound and economic solution

Treston chairs ensure safety in the workplace by fulfilling the requirements of DIN 68877 and by carrying the GS safety mark, and in addition, our ESD chairs are in compliance with EN 61340-5-1. Besides being safe and ergonomic, our chair selection has a full 10 year warranty\*. The Treston chair range is a safe, sustainable and economic solution for industrial seating.

\* Saddle chairs 2 years



[treston.com/catalogues-and-brochures](http://treston.com/catalogues-and-brochures)

**READ MORE ABOUT  
ergonomic sitting from our  
separate brochure!**



## Treston Ergo

### Multipurpose chair for almost any application in the industry

- Durable seating options for demanding environments
- Supports forward-leaning work and reduces lower back strain
- Easy adjustments make them ideal for shared workstations



## Treston Plus

### The all-inclusive ergonomic package

- Fully adjustable ergonomic chair for prolonged sitting
- Supports natural posture and reduces upper body strain
- Promotes active sitting with synchronous mechanism



## Neon

### New generation workplace chair

- Modular chair with long service life and replaceable parts
- Protective edge improves durability in demanding use
- Fully adjustable for flexible and shared workstations



## Flex standing rest

### For best support in standing work and combined workplaces

- 360° rotation of the seat, easy height adjustment of foot ring
- Sit-stand support reducing strain during prolonged standing
- Slip resistant seat



## Stools

- Compact solution for dynamic work and frequent movement
- Supports active working and flexible posture changes
- Durable, easy-to-clean surfaces for industrial use



## Saddle chairs

- Enables a semi-standing posture that supports natural body alignment
- Promotes movement and reduces lower back strain
- Ideal for dynamic work and height-adjustable workstations



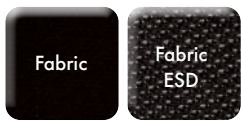

Treston Ergo chair with fabric upholstery

	Treston Ergo 30	Treston Ergo 30 ESD	Treston Ergo 35	Treston Ergo 35 ESD
Description	With soft dual-wheel safety castors (conductive with ESD versions) with load-sensitive brakes.		High version with foot ring and glides (conductive with ESD versions).	
Upholstery	The high-quality fabric upholstery is breathable and can both absorb and expel moisture.			
Code	C30BL	C30BL-ESD	C35BL	C35BL-ESD



Treston Ergo chair with artificial leather upholstery

	Treston Ergo 30 AL	Treston Ergo 30 AL ESD
Description	With soft dual-wheel safety castors (conductive with ESD versions) with load-sensitive brakes.	
Upholstery	Artificial leather upholstery is washable, resistant to disinfectants and easy to care.	
Code	C30AL	C30AL-ESD



Treston Ergo chair with polyurethane foam (PU)

	Treston Ergo 20 PU	Treston Ergo 20 PU ESD	Treston Ergo 25 PU	Treston Ergo 25 PU ESD
Description	With soft dual-wheel safety castors (conductive with ESD versions) with load-sensitive brakes.		High version with foot ring and glides (conductive with ESD versions).	
Upholstery	The PU surface is highly resistant, extremely robust, washable and very easy to clean.			
Code	C20PU	C20PU-ESD	C25PU	C25PU-ESD



### Treston Plus chair with fabric or artificial leather upholstery

	Treston Plus 40 BL	Treston Plus 40 BL ESD	Treston Plus 40 AL	Treston Plus 40 AL ESD
Description	With soft dual-wheel safety castors (conductive with ESD versions) with load-sensitive brakes			
Upholstery	Black fabric	Black fabric ESD	Artificial leather	Artificial leather ESD
Code	C40BL	C40BL-ESD	C40AL	C40AL-ESD



### Neon chair with fabric upholstery

	Neon 50 ESD
Description	With conductive soft dual-wheel safety castors with load-sensitive brakes.
Upholstery	Black fabric ESD, grey flex strip
Code	C50BL-G-ESD



### Flex standing rest with polyurethane foam (PU)

	Flex 19	Flex 19 ESD
Description	High version with foot ring and glides (conductive with ESD versions).	
Upholstery	The PU surface is highly resistant, extremely robust, washable and very easy to clean.	
Code	C19PU	C19PU-ESD



**Stool with polyurethane foam (PU) or artificial leather**

	Stool PU	Stool AL-ESD
Description	With soft dual-wheel safety castors (conductive with ESD versions) with load-sensitive brakes	
Upholstery	Polyurethane PU	Artificial leather ESD
Code	C15PU	C15AL-ESD



**Saddle chair with fabric or (artificial) leather upholstery**

	Saddle G ESD	Saddle AL ESD	Saddle L
Description	With soft dual-wheel safety castors (conductive with ESD versions) with load-sensitive brakes		
Upholstery	Grey fabric ESD	Artificial leather ESD	Leather
Code	SADDLE G ESD	SADDLE AL ESD	SADDLE L

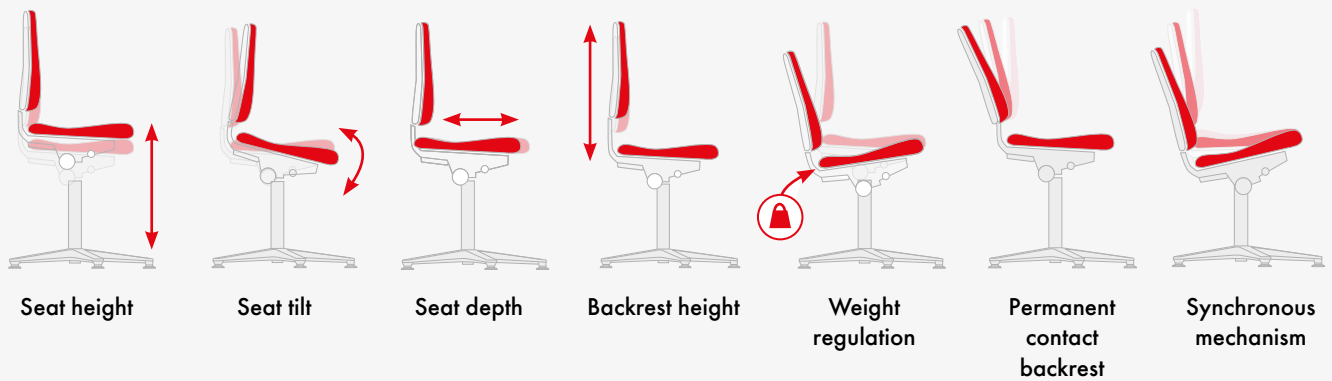

Adjustments and features	Treston Ergo	Treston Plus	Neon	Stool	Saddle chair	Flex – standing rest
Seat height	✓	✓	✓	✓	✓	✓
Seat tilt	✓	✓	✓		✓	
Seat depth		✓	✓			
Backrest height	✓	✓	✓			
Contact backrest	✓					
Synchro mechanism		✓	✓			
Arm rests as an option	✓	✓	✓			
Changeable upholstery			✓			

Code	Description / Upholstery / Colour	Martindale	Seat height, mm*	Seat width, mm	Seat depth, mm	Backrest height, mm	Weight, kg
<b>Stools</b>							
C15PU	Stool 15 polyurethane black		460-630	350	350		7,0
C15AL-ESD	Stool 15 artificial leather black ESD	50.000	460-630	400	400		8,0
<b>Flex standing rests</b>							
C19PU	Flex 19 polyurethane black		510-780	360	380	200	13,0
C19PU-ESD	Flex 19 polyurethane black ESD		510-780	360	380	200	13,0
<b>Treston Ergo chairs</b>							
C20PU	Treston Ergo 20 polyurethane black		440-620	440	410	380	11,5
C20PU-ESD	Treston Ergo 20 polyurethane black ESD		440-620	440	410	380	13,0
C25PU	Treston Ergo 25 polyurethane black		580-850	440	410	380	13,5
C25PU-ESD	Treston Ergo 25 polyurethane black ESD		580-850	440	410	380	15,0
C30AL	Treston Ergo 30 artificial leather black	50.000	440-620	460	470	460	12,0
C30AL-ESD	Treston Ergo 30 artificial leather black ESD	50.000	440-620	460	470	460	13,0
C30BL	Treston Ergo 30 fabric black	50.000	440-620	460	470	460	12,0
C30BL-ESD	Treston Ergo 30 fabric black ESD	40.000	440-620	460	470	460	13,0
C35BL	Treston Ergo 35 fabric black	50.000	580-850	460	470	460	14,0
C35BL-ESD	Treston Ergo 35 fabric black ESD	40.000	530-800	460	470	460	15,0
<b>Treston Plus chairs</b>							
C40AL	Treston Plus 40 artificial leather black	50.000	450-600	460	410-470	600	18,5
C40AL-ESD	Treston Plus 40 artificial leather black ESD	50.000	450-600	460	410-470	600	19,5
C40BL	Treston Plus 40 fabric black	50.000	450-600	460	410-470	600	18,5
C40BL-ESD	Treston Plus 40 fabric black ESD	40.000	450-600	460	410-470	600	19,5
<b>Neon chairs</b>							
C50BL-G-ESD	Neon 50 fabric black ESD grey strips	40.000	450-620	470	420-480	570	18,0
<b>Saddle chairs</b>							
SADDLE G ESD	Saddle chair fabric grey ESD	> 50.000	575-820	420	350		7,0
SADDLE AL ESD	Saddle chair artificial leather ESD black		575-820	420	350		7,0
SADDLE L	Saddle chair leather black		575-820	420	350		7,0

\* According to the DIN 68877, the seat height is measured from the floor to the centre of the seat with a 64-kg load. The maximum load capacity of the chairs is 120 kg.

### Accessories for chairs

Product	Description	Code	Code ESD
High glide set	Abrasion-resistant plastic glides have a large surface area and offer superb level of stability. The glides can be retrofitted to all our chairs.	CGLIH	CGLIH-ESD
Soft castor set for hard floor	Dual-wheel safety castors are equipped with load-sensitive brakes, which means that the castors will brake when unloaded. As a standard, we supply soft castors for hard floors, but hard castors for soft floors need to be ordered separately.	CSCAS	CSCAS-ESD
Hard castor set for soft floor		CHCAS	CHCAS-ESD
Soft Stop&Go castor set for hard floors	In case the high chair needs to be moved around the workplace, Stop&Go castors will provide a safe solution. These castors will brake as soon as they are loaded, but when not loaded, the chair is easy to move around.	CSTOP	CSTOP-ESD
4D armrests for Treston Ergo and Treston Plus	Adjustment of height, width and depth with the possibility to swivel.	ARE	
4D ESD armrests for Treston Ergo ESD and Treston Plus ESD	Adjustment of height, width and depth with the possibility to swivel.		ARE-ESD
4D armrests for Neon	Adjustment of height, width and depth with the possibility to swivel.		ARN-ESD
Chrome-plated foot ring	Foot ring can also be retrofitted to our lower chair models by attaching it to the chair column. Can be used on both ESD and non-ESD models. The height can be easily adjusted without any tools.	CRING	CRING

## 5. Trolleys



Work smarter, not harder

# Freedom of mobility with trolleys



Work is not always confined to a single workstation and tools must be moved around accordingly. Lightweight trolleys are ideal for this situation, significantly increasing productivity up to 30%.

The trolleys provide extra work or storage space and can be used, for example, to transport various items, to store measuring units and keep a buffer stock on a production line.

Each task is different and requires dedicated tools. Due to their modularity and versatile accessory components, trolleys are easy to design and adapt to suit a multitude of users and applications.



Watch this video: [How to choose an ergonomic trolley for industrial tasks](#)

# Ergonomics for manual handling of loads

Manual handling of loads (also known as MMH – manual materials handling) means moving or handling things by lifting, lowering, pushing, pulling, carrying, holding, or restraining. Manual handling of loads is generally considered to be an occupational risk factor for low back and shoulder complaints and it is in fact the most common cause of occupational fatigue, low back pain and lower back injuries. Therefore, it should not come as a surprise that paying attention to ergonomics for manual handling of loads is extremely important for the safety and health of the workers as well as for the efficiency and productivity of the processes.

## Pushing and pulling from an ergonomics viewpoint

Pushing and pulling are the two physical tasks most commonly related to working on and operating trolleys. The most common risk factors, related to pushing and pulling tasks, which could hinder the ergonomics, are forceful pushing/pulling, trolley design that does not promote neutral body postures, wrong direction of exerted forces (e.g. pulling when you should be pushing), one handed pushing or pulling, too heavy loads and wrong handle height.

A task suitable trolley that adapts to the size of the user is the answer to reducing the risk of work related musculoskeletal disorders (WMSD), especially for lower back, knee and shoulder injuries. When selecting a trolley for the task, you should always consider the human body power zones, where people have the greatest strength and most comfort working. See the image on the right as a reference. Trolley design should ensure that pushing and pulling can be done from the optimal height, between the knuckle and shoulder height of the worker, with the arms as close to the body as possible. Working in your power zone reduces the start force needed for pushing and pulling, reduces the effort and force needed to perform work tasks, and reduces the stress on your back and shoulders.

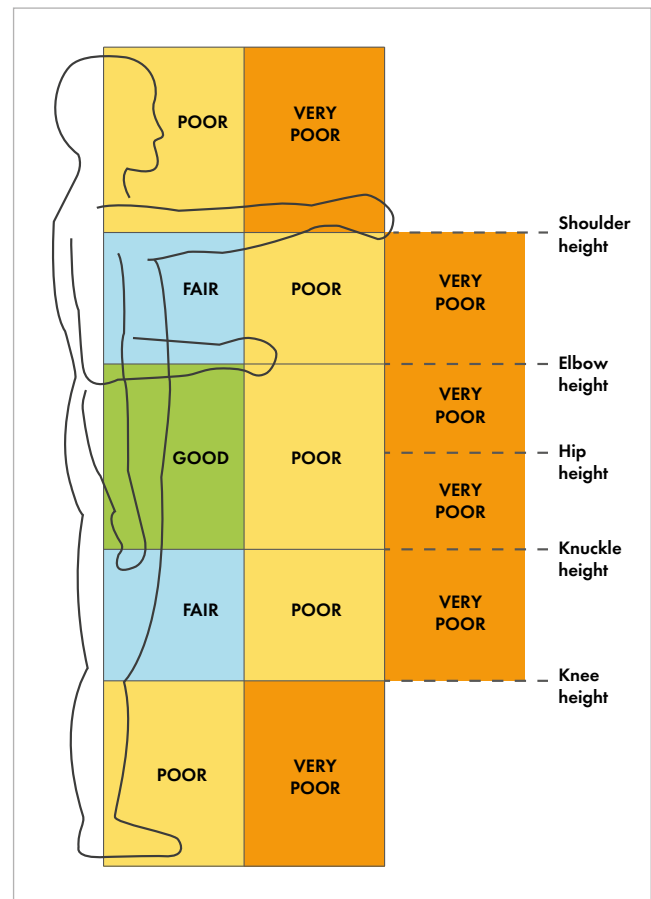
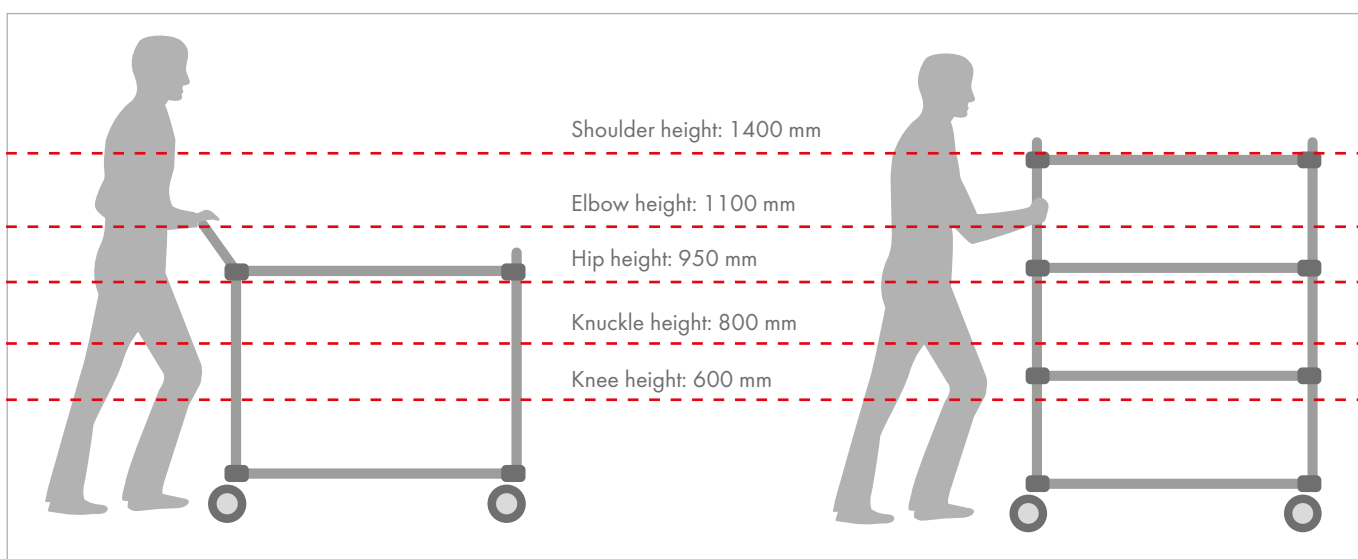

Illustration on the power zones where people have the greatest strength and most comfort, in regards of lifting and placing loads, pushing and pulling (i.e. above the knees, below the shoulders, and close to the body).

## Consider the handle position and design

Vertical handles are considered the most optimal, as every sized worker is able to grasp the handles in their unique power zone. Handles can be horizontal as well, as long as they are the correct height for the user. Preferred handle height is between the shoulder and knuckle height of the worker, optimising the force applied for pushing and pulling.

The optimal shape for handles is cylindrical and smooth, which allows the best power grip with straight wrists. The handle diameter should be big enough to enable power grip instead of pinch grip. Power grip provides up to 75% more strength compared to pinch grip. Power grip involves grasping the handle by wrapping all the fingers around it, instead of grasping with thumb and tips of the other fingers.



**Elbow height is the optimal position in regard to push forces. Displayed heights are indicative for average sized male.**

## CHANGE IN THE NATURE OF MANUAL LOAD HANDLING TASKS

In the past decades, industrial workspaces have been mostly redesigned so that carrying objects has been replaced by transporting objects by pushing or pulling them in trolleys, carts, hand pallet trucks and such. For example, in the automotive supply sector about 10% of all working processes involve pushing and pulling on a regular and repetitive basis.

In addition, the rapid growth of the e-commerce sector has increased the number of distribution centres worldwide. The primary job at these distribution centres is order picking and delivery, where manual handling aids such as carts, trolleys, hand pallet trucks and such are used to perform the tasks. The use of these aids has again eliminated carrying objects, changing the nature of manual load handling tasks predominantly to pushing and pulling.

In general, it has been estimated that nearly half of common manual load handling tasks in workplaces consist of pushing and pulling exertions performed on level surfaces and variable inclined ramps.

## Castors play an important role

A quality castor is of the appropriate size in relation to the working environment and purpose of the trolley. The bigger the castor, the easier it is to move the trolley. For example, big castors make it easier to push the trolley over thresholds and other similar obstacles. The tread in quality castors withstands wear and tear. The wheel/tread material is not the only factor influencing the usability and easy movability of the trolley, as the flooring material also affects how well the castor rolls and moves.

Swivel castors are also handy on a trolley, making it easy to manoeuvre even in small spaces. We recommend using



four swivel castors in tight spaces, making it easier to turn and control loads. Strong castor brakes lock the trolley in position, making sure that it stays where it is supposed to be.

Castors have a big effect in minimizing the start forces needed to get the trolley moving as well as in reducing the rolling resistance and therefore play an important role in ensuring proper ergonomics. The amount of force required to move loads with trolleys depends on a number of factors:

- weight and shape of the load
- type and condition of floor surface (e.g. smoothness and density)
- route taken (e.g. slopes and obstacles)
- type of castor, especially the materials used
- size of castor
- maintenance of castors – cleaning, lubricating and/or replacing castors on a regular basis has a vital effect in maintaining the ride comfort and minimizing the push effort.

## Task experience is the key to reducing strain

Task experience and correct working technique in pushing and pulling play an important role in reducing some measures of biomechanical strain and therefore yield potential for reducing the risk of injury. For example, pulling a lighter weight trolley at hip height, with arms outstretched, would result in very high compressive force at the lower back, as opposed to pushing a much heavier trolley between shoulder and elbow height, arms closer to body, which results in much less of a compressive force at the lower back. As a reference, see the illustration on the power zones where people have the greatest strength and most comfort.

If your goal is to ensure efficient processes and ergonomic working conditions, start by selecting the correct type of trolley for the task and then orientating all workers with the physical aspects and best working techniques for the specific task at hand. No matter how fancy the features of your trolley, if your workers use bad techniques while performing their tasks with the trolley, you are sure to increase the risk of injuries and create inefficiency in processes. If necessary, modify work practices so that workers can perform their tasks and work within their power zone.



Although there is no exact weight limit that is safe, a weight of 20–25 kg is heavy to lift for most people and it thus increases the risk of back injury.



# What to consider when selecting a trolley?

Selecting the right trolley is not complicated, but there are certain considerations to take into account to ensure you get the best possible trolley for your needs.

1. **Why do you need the trolley?** What is its purpose? Are flexibility and easy reconfiguration important features of the trolley? If you have a fixed task and fixed need for the trolley, a specific trolley for that need will most likely be the best solution for you. But if you need a trolley that can be easily adapted to changing needs and production processes, choose a trolley that has a modular structure, a wide range of accessories, and good ergonomics, which will help you flexibly adapt the trolley to a multitude of tasks.
2. **What are the objects being handled on the trolley?** Are you moving lightweight boxes of the same size and weight or bulky equipment that can differ in size and weight? The weight and shape of the objects handled determine the load capacity and shelf and work surface size of your trolley. If the size of handled objects varies, select a height adjustable work surface and/or shelves to ensure proper ergonomics no matter what size of objects you handle. Tilted shelves improve access and handling of objects, as it enables you to work from your power zone.
3. **How are the objects handled?** Are they sorted or unsorted? Can you stack them or are they loose? Especially for unsorted and loose objects, it is better to equip the trolley shelves with edges and/or rubber mats, to ensure the goods do not fall over when moving. Remember though that shelves with edges make it more difficult to handle, lift and lay down heavy objects. Another possibility is to use a caged trolley, where the side walls of the trolley are at least partially closed in order to help keep objects in place. Mesh panels are a good option for this: they allow visual inspection and keep the construction light.
4. **What kind of working environment is it?** Do you have to enter doors with the trolley? How wide are the walkway spaces? If you have to move through doors in different workspaces and/or long distances within the space, check the walkway and door widths to ensure sufficient space.
5. **What type of castors should I have?** A quality castor is of the appropriate size in relation to the working environment and purpose of the trolley. Castors have a big effect in minimizing the start forces needed to get the trolley moving as well as in reducing the rolling resistance and therefore play an important role in ensuring proper ergonomics.
6. **How about handles?** Trolleys that are moved around a lot and transported for longer distances should be equipped with at least one handle, to make handling, pushing and pulling easy, effortless and ergonomic. Vertical handles are considered the most optimal, as every sized worker is able to grasp the handles in their unique power zone. Preferred handle height is between the shoulder and knuckle height of the worker, optimizing the force applied for pushing and pulling. The optimal shape for handles is cylindrical and smooth, which allows the best power grip with straight wrists.
7. **How often is the trolley used?** If you have a trolley in active everyday use, invest in a high quality, reliable and durable trolley with high quality castors. This might be a more expensive initial investment, but in the long run a high quality trolley will pay for itself with its long lifetime and flexibility in use.
8. **Consult the people using the trolley in their work.** They have the best hands-on experience and can give valuable input on the required features, such as size and load capacity, as well as on the accessories needed to perform the work ergonomically and efficiently. Knowing your loads helps you to buy equipment of appropriate capacity.
9. **How ergonomic is the trolley?** As a quick ergonomics check, make sure the handles, work surfaces, and accessories are easily height adjustable to adjust to the worker and task at hand to ensure proper ergonomics. If your goal is to ensure efficient processes and ergonomic working conditions, start by selecting the correct type of trolley for the task and then orientating all workers with the physical aspects and best working techniques for the specific task at hand. No matter how fancy the features of your trolley, if your workers use bad techniques while performing their tasks with the trolley, you are sure to increase the risk of injuries and create inefficiency in processes.



150 kg



300 kg



150 / 300 kg

**Universal trolley WTR,**  
page 124

Most often combined with WB workstations to provide extra storage space. A good adjustable PC station, measuring station or mobile storage, best suitable for moving equipment around the workstation.

**Industrial Multi trolley,**  
page 125

This trolley can be equipped with shelves, tops and other module-sized accessories to fit any application, such as transportation or tool storage. The trolleys support heavy loads, but they are easy to move as well.

**Adjustable trolley TRTA,**  
page 128

For general use wherever a good transportation and storage solution is needed. Two or four shelves available; height of the shelves can be adjusted. Mesh panels can be installed at the ends or on the sides. Also a SMD reel holder version available.



12 / 25 kg



90 kg



150 kg



150 kg

**Mobile workstations,**  
page 130

A light, ergonomic and easy-to-move workstation. The mobile workstation moves and turns effortlessly even in tight spaces. Used wherever a laptop is needed on the go.

**Trolleys for additional workspace,**  
page 131

Additional worktop space is often needed in workspaces. Equipped with castors, they can be moved around easily and can also be used to transport supplies. The product family includes many models for different purposes.



150 kg

### Packing trolleys, page 132

Handy trolleys designed with packing in mind provide space to keep boxes and other materials within arm's reach, but they also can be moved aside as needed.



600 kg

### Heavy-duty trolley, page 134

Heavy-duty trolleys, as their name indicates, are ideal for moving heavy loads. Their special castors support extremely heavy weights.



300 kg

### Fitter's trolley, page 135

A fitter's trolley lets you take your supplies and tools wherever you go, while keeping them organised. Rubber mats and ESD-mats for shelves available separately.



300 kg

### Tool trolley, page 136

Sturdy tool trolley for workshop and garage environment. Tool trolley is very practical working surface with drawers and cabinets to store tools and components. Several combinations available.



300 kg

### Bin and cabinet trolleys, page 138

The bin and cabinet trolleys can be equipped with Treston stacking bins and bin cabinets based on own needs. Trolleys enable supplies and parts to be moved smoothly to wherever they are needed.

# Universal trolley WTR

A high quality, versatile trolley, PC-station, measuring station or mobile storage trolley. Modern industrial design.

The standard trolley has 3 shelves (TS 605), size 650 x 530 mm. Height adjustment of shelves is by allen-key. The vertical profiles are of aluminium. Frames are of epoxy powder coated steel: light grey RAL 7035. The worktops are of 25 mm laminated particle board. Four swivel castors (Ø 100 mm) two of which have brakes, overall height of castor 130 mm.



## Universal trolley WTR

Name	Size W x D x H mm	Max load kg	Code	Code ESD
1. Universal trolley	660 x 650 x 1415	150	WTR140	WTR140 ESD
2. Extra shelf	530 x 650	50	TS605	TS605 ESD
3. Adjustable shelf*	530 x 650	50	TAS605	TAS605 ESD
4. Bin profile	Length 525		BP50	BP50 ESD
5. Power rail	Length 468 mm		TPR4-001	
6. Keyboard tray NT	525 x 399 x 133 (outer) 500 x 250 x 110 (inner)		-	NT 500 ESD

\*Continuous adjustment for depth, height and angle.



# Treston Industrial Multi trolley

Treston Industrial Multi Trolley is suitable for various industrial tasks and environments and can easily be customised with a wide range of accessories. Multi trolleys are available in three different widths: M500, M750 and M900. This means that all our module-sized accessories can be used with the trolleys.

Multi trolleys support heavy loads, but they are easy to move as well, making it simple to transport heavy equipment, such as measuring units. They are equipped with four swivel castors (Ø 125 mm), two of which have brakes. The sturdy shelves can be height-adjusted and tilted. Shelves come with raised edges which keep the load in place.

## Treston Industrial Multi trolley with adjustable shelves

Description	Module	Size W x D x H mm	Max load kg	Code	Code ESD
1. 4 adjustable shelves	M500	540 x 760 x 1790	300	TMTH5-002-41	TMTH5-002-49
	M750	790 x 760 x 1790	300	TMTH7-002-41	TMTH7-002-49
	M900	943 x 760 x 1790	300	TMTH9-002-41	TMTH9-002-49
2. 2 adjustable shelves	M500	540 x 760 x 1150	300	TMTL5-002-41	TMTL5-002-49
	M750	790 x 760 x 1150	300	TMTL7-002-41	TMTL7-002-49
	M900	943 x 760 x 1150	300	TMTL9-002-41	TMTL9-002-49

Bottom shelf and mats for shelves, see page 127.



## Treston Industrial Multi trolley with shelves

Description	Module	Size W x D x H mm	Max load kg	Code	Code ESD
3. 4 shelves	M500	540 x 760 x 1790	300	TMTH5-001-41	TMTH5-001-49
	M750	790 x 760 x 1790	300	TMTH7-001-41	TMTH7-001-49
	M900	943 x 760 x 1790	300	TMTH9-001-41	TMTH9-001-49
4. 2 shelves	M500	540 x 760 x 1150	300	TMTL5-001-41	TMTL5-001-49
	M750	790 x 760 x 1150	300	TMTL7-001-41	TMTL7-001-49
	M900	943 x 760 x 1150	300	TMTL9-001-41	TMTL9-001-49

Bottom shelf and mats for shelves, see page 127.



**1. Treston Industrial Multi trolley with perforated panels**

Module	Size W x D x H mm	Max load kg	Code	Code ESD
M750*	790 x 760 x 1790	300	TMTH7-005-07	TMTH7-005-49
M900	943 x 760 x 1790	300	TMTH9-005-07	TMTH9-005-49

\*Also available in black: TMTH7-005-18

**2. Treston Industrial Multi trolley with tilted perforated panels**

Module	Size W x D x H mm	Max load kg	Code	Code ESD
-	820 x 760 x 1860	300	TMTA-41	TMTA-49

**3. Treston Industrial Multi trolley with perforated tool cabinet**

Module	Size W x D x H mm	Max load kg	Code
M750	790 x 760 x 1790	300	TMTH7-104-07



# Industrial Multi trolley frame and accessories

- Equip your trolleys with shelves, tops and other accessories to fit any application, such as transportation or tool storage.
- All trolleys are equipped with four swivel castors (Ø 125 mm), two of which have brakes.
- Can easily be customised with a wide range of accessories, to meet individual needs.

**Treston Industrial Multi trolley frame**

Name	Module	Size W x D x H mm	Max load kg	Code	Code ESD
Frame High	M500	540 x 760 x 1790	300	TMTFH5-41	TMTFH5-49
Frame High	M750	790 x 760 x 1790	300	TMTFH7-41	TMTFH7-49
Frame High	M900	943 x 760 x 1790	300	TMTFH9-41	TMTFH9-49
Frame Low	M500	540 x 760 x 1150	300	TMTFL5-41	TMTFL5-49
Frame Low	M750	790 x 760 x 1150	300	TMTFL7-41	TMTFL7-49
Frame Low	M900	943 x 760 x 1150	300	TMTFL9-41	TMTFL9-49



**Bottom shelf**

Name	Module	Size W x D x H mm	Max load kg	Code ESD
Bottom shelf M500 x 728	M500	460 x 728 x 33	100	TMTLS5-49
Bottom shelf M750 x 728	M750	710 x 728 x 33	100	TMTLS7-49
Bottom shelf M900 x 728	M900	863 x 728 x 33	100	TMTLS9-49



Bottom shelf

**Steel shelf**

Name	Module	Size W x D x H mm	Max load kg	Code ESD
Steel shelf M500 x 650 + brackets	M500	468 x 650 x 33	100	TMTS5-49
Steel shelf M750 x 650 + brackets	M750	718 x 650 x 33	100	TMTS7-49
Steel shelf M900 x 650 + brackets	M900	871 x 650 x 33	100	TMTS9-49

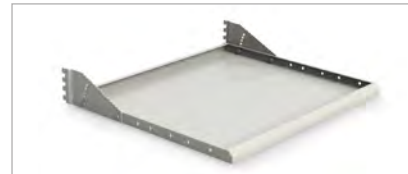

Steel shelf

**Adjustable shelf, stepless tilt**

Name	Module	Size W x D x H mm	Max load kg	Code ESD
Adjustable shelf M500 x 650	M500	468 x 650 x 37	100	TMTAS5-49
Adjustable shelf M750 x 650	M750	718 x 650 x 37	100	TMTAS7-49
Adjustable shelf M900 x 650	M900	871 x 650 x 37	100	TMTAS9-49



Adjustable shelf, stepless tilt

**Adjustable shelf, stepless depth and tilt**

Name	Module	Size W x D x H mm	Max load kg	Code ESD
Adjustable shelf M500 x 650	M500	468 x 650 x 37	50	TMTSAS5-49
Adjustable shelf M750 x 650	M750	718 x 650 x 37	50	TMTSAS7-49
Adjustable shelf M900 x 650	M900	871 x 650 x 37	50	TMTSAS9-49



Adjustable shelf, stepless depth and tilt

**Mats for shelves**

Suitability	Module	Size W x D mm	Code	Code ESD
Lower shelf TMTLS5-49	M500	455 x 723	725742-00	725750-49
Lower shelf TMTLS7-49	M750	705 x 723	725739-00	725747-49
Lower shelf TMTLS9-49	M900	858 x 723	725740-00	725748-49
Steel shelf TMTS5-49	M500	463 x 645	725738-00	725746-49
Steel shelf TMTS7-49	M750	713 x 645	725735-00	725743-49
Steel shelf TMTS9-49	M900	866 x 645	725736-00	725744-49
Adjustable shelf TMTAS5-49 and TMTSAS5-49	M500	428 x 600	860823-00	860821-00
Adjustable shelf TMTAS7-49 and TMTSAS7-49	M750	678 x 600	860548-00	860318-00
Adjustable shelf TMTAS9-49 and TMTSAS9-49	M900	831 x 600	860550-00	860320-00



Mats for shelves

**Industrial Multi trolley accessories**

Name	Size W x D x H mm	Max load kg	Code	Code ESD
Wash basket	380 x 302 x 110	20	839 116-51	-
Waste basket 9 L	320 x 220 x 270		839 159-ECO	-
Waste basket holder*			-	835 773-49
Paper roll holder*	Roll dimensions max: width 240 mm, Ø 230 mm)			860 310-49
Flow-through shelf**	718 x 835 x 61	150	-	890 710-49

For perforated panels, see page 183, for R-hooks, see page 192.

\* fixing to upright

\*\*including brackets



Wash basket, waste basket, paper roll holder



Flow-through shelf

# Adjustable trolley TRTA

For general use in workshops, offices, production areas and hospitals. Shelves are powder coated steel, RAL 7035 ESD, height 28 mm. All shelves are individually adjustable. The structure is light but sturdy. The end-frames of the trolley are made of round, powder coated steel tube (25 mm). Four swivel castors (Ø 125 mm), two of which have brakes.

## Adjustable trolley TRTA

Name	Size W x D x H mm	Shelf size W x D mm	Max load kg	Code	Code ESD
2-shelf trolley*	890 x 530 x 1020	800 x 430	150	TRTA4082	TRTA4082 ESD
2-shelf trolley*	1090 x 530 x 1020	1000 x 430	150	TRTA4102	TRTA4102 ESD
2-shelf trolley*	890 x 630 x 1020	800 x 530	150	TRTA5082	TRTA5082 ESD
2-shelf trolley*	1090 x 630 x 1020	1000 x 530	150	TRTA5102	TRTA5102 ESD
4-shelf trolley**	1090 x 530 x 1515	1000 x 430	300	TRTA4104	TRTA4104 ESD
4-shelf trolley**	1090 x 630 x 1515	1000 x 530	300	TRTA5104	TRTA5104 ESD

Max load 50 kg / shelf.

\* Shelf adjustments between 200-770 mm

\*\* Shelf adjustments between 200-1340 mm

## Extra shelves TRHA

Name	Shelf size W x D mm	Max load kg	Code	Code ESD
Extra shelf	800 x 430	50	TRHA408	TRHA408 ESD
Extra shelf	1000 x 430	50	TRHA410	TRHA410 ESD
Extra shelf	800 x 530	50	TRHA508	TRHA508 ESD
Extra shelf	1000 x 530	50	TRHA510	TRHA510 ESD

## End mesh panels NET2

Name	Size W x D mm	Set	Code ESD
End mesh panel	604 x 364	Incl. 2 panels	NET2

The mesh panels can be installed at the ends of the trolley or on the sides. An angle bracket is set on the edge of the upper and lower shelf and the mesh is screwed into place. The 4-shelf trolley can hold 2 mesh panels on top of each other.

## Document holder DSA4

Name	Size	Code ESD
Document holder	A4	DSA4 ESD

Semiconductive epoxy powder coated steel. Includes two blue magnets.

## Low M-divider hoops LDH

Name	Size	Code
Divider hoops	460 x 315	LDH

Steplessly adjustable. 4 pcs per set. M-shape (the lowest point 105 mm from shelf). Suitable only 430 mm deep shelves.



Low M-divider hoops LDH

Document holder

# Reel holder trolley RRT

The adjustable reel holder trolley is compatible with SMD reels, and suitable for transport and stocking of them. All parts are powder coated steel, RAL 7035 ESD. The trolley has four perforated steel shelves, 1090 x 460 x 28 mm. All shelves are individually adjustable between 200-1605 mm.

The zinc plated reel racks that fit into the shelves are to be ordered separately. The structure is light but sturdy. The endframes of the trolley are made of round, powder coated steel tube (25 mm). Four turning castors with brakes (Ø 125 mm). The load capacity of one shelf is 50 kg, and the load capacity of the trolley is 200 kg.

## Reel holder trolley RRT

Name	Size W x D x H mm	Max load kg	Code ESD
1. Reel holder trolley	1100 x 530 x 1780	200	RRT ESD
2. Reel rack	960 x 426 x 254	50	RR ESD-Z
3. Document holder	A4		DSA4 ESD

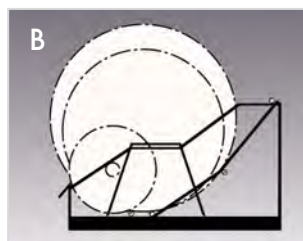
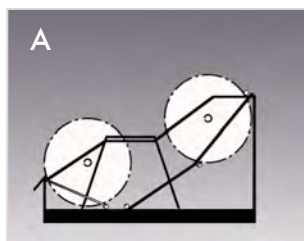

In picture A: Side view of spools and reel racks. The capacity of one rack is 30 fixed compartments for 7" spools of 60 mm width.

In picture B: Side view of spools and reel racks. The capacity of one rack is 15 fixed compartments for 13" and 15" spools of 60 mm width.

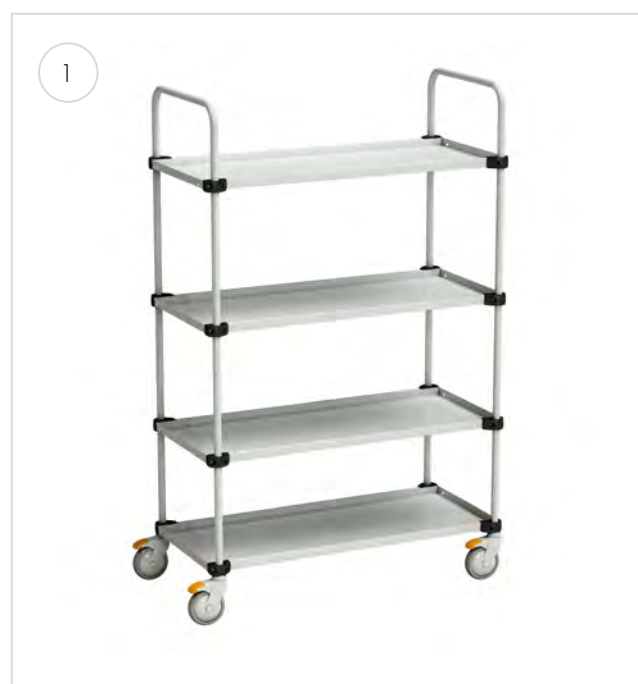

# Mobile workstations

**MLC mobile workstation** is a light, ergonomic and easy-to-move workstation. The mobile workstation moves and turns effortlessly even in tight spaces. A laptop computer can be placed on the worktop or underneath it, in which case only the screen is visible. A wide range of accessories is available, with all the necessary supplies included.

- An ergonomic workstation that is light to move around - aluminium frame, steel legs
- Standard features include a laminated worktop and a lockable computer compartment with holes for wires
- Four swivel castors (Ø125 mm), two with brakes



MLC mobile workstation

**MLCT mobile height adjustable work surface** is a compact sized additional work surface with easy gas spring height adjustment. It is ideal for tight spaces and tasks where easy manoeuvrability is a must. Optimal for handling light loads and small sized objects. Ideal also for laptop use. Suitable for technical and EPA environments where easy ergonomics and mobility are required.

- Easy to move around due to the light construction - aluminium frame, symmetric steel legs
- Accessories available: Accessory box underneath the table top, accessories basket to the frame and a folder holder
- Four swivel castors (Ø100 mm), two with brakes



MLCT mobile height adjustable work surface

## Mobile workstations

Name	Size W x D mm	Height mm*	Top size mm	Max load kg	Code	Code ESD
Mobile workstation	590 x 540	800-1200	520 x 370 x 25	12	MLC 405PG	MLC 405PG ESD
Mobile height adjustable work surface	600 x 500	760-1185	580 x 490 x 25	25**	MLCT 605PG	MLCT 605PG ESD

\*Height is adjusted by gas spring.

\*\* 150 N gas spring lightens the load with app. 10 kg upon lifting.

## Mobile workstation accessories

Name	Description	Suitability	Code
1. Keyboard and mouse tray	210 x 620 mm. Equipped with a wrist support.	MLC	KH620N
2. Binder mount	Fits a single 75 mm wide binder.	MLC, MLCT	FH1
3. Accessories basket	Blue bin, int. dim. 230 x 155 x 140 mm	MLC, MLCT	AB1930
4. LCD bracket MH	Load capacity 15 kg, mounting holes 75 x 75 / 100 x 100 apart.	MLC	MH
5. Tablet bracket MY	For 7-10" tablets. Requires LCD bracket MH.	MLC	MY
6. LCD support arm MS	For the attachment of MH and MY brackets. Max 22" screen.	MLC	MS
7. Accessory box	With grey shelf bin 4020-3.	MLCT	AB4020-3
7. Accessory box ESD	With ESD shelf bin 4020-4ESD.	MLCT	AB4020-4ESD



1



2



3



4



5



6



7

# Trolleys for additional workspace

**Storage trolley** is an easy solution for mobile storage, the storage trolley has an adjustable middle shelf, and the shelves are fitted with ESD or standard rubber mats.

**SAP trolley** is an easily movable additional work surface with height adjustment. Lower self, extra shelf and handle are available separately. Height adjustment with allen key between 650-900 mm.

**Concept trolley** is an additional work surface with height adjustment and an integrated bottom shelf. Can be equipped with an additional shelf or drawer unit 30 series. Height adjustment with allen key between 650-900 mm.



## Trolleys for additional workspace

Name	Size W x D x H mm	Max load kg	Code	Code ESD
Storage trolley	650 x 450 x 775	3 x 30	852 773-41	852 773-49
SAP trolley	700 x 500	150	SAP507	SAP507 ESD
SAP trolley	1000 x 700	150	SAP710	SAP710 ESD
Lower shelf for SAP trolley	700 x 500	40	AT507	AT507 ESD
Lower shelf for SAP trolley	1000 x 700	40	AT710	AT710 ESD
Extra shelf for SAP trolley	700 x 500	40	LT507	LT507 ESD
Extra shelf for SAP trolley	1000 x 700	40	LT710	LT710 ESD
Handle for SAP trolley	depth 500		PUSH50	PUSH50
Handle for SAP trolley	depth 700		PUSH70	PUSH70
Concept trolley	500 x 700 x 650-900	150	CONT705-41	CONT705-49
Extra shelf for Concept trolley	400 x 500	25	CONTS504-49	CONTS504-49
Drawer unit 35/10	350 x 470 x 105	10	DU3510-49	DU3510-49
Drawer unit 35/20	350 x 470 x 210	10 / drawer	DU3520-49	DU3520-49
Drawer unit fastening set			855 062-49	855 062-49

All the light-duty trolleys are equipped with four swivel castors (ø 100 mm), two of which have brakes.



Storage trolley



SAP trolley with AT lower shelf, LT extra shelf and PUSH handle



Concept trolley, extra shelf and drawer unit 35/10

# Packing trolleys

## Low carton trolley LCT610

Trolley for large cartons. Three dividers can be assembled crosswise or lengthwise. The fourth divider is a push handle.

Frame and shelf are of epoxy powder-coated steel in grey RAL 7035. Four swivel castors (Ø 100 mm), two of which have brakes. Shelf height above the ground 160 mm.



Size W x D x H mm	Shelf size W x D mm	Max load kg	Code
1080 x 630 x 1020	1000 x 630	150	LCT610

## High carton trolley HCT410

Trolley for packing cartons. Shelves are equipped with steplessly adjustable steel M-divider hoops. Larger hoop height 540 mm, lowest point 330 mm above the shelf, smaller hoop height 315 mm, lowest point 105 mm above the shelf.

Frame and individually height adjustable shelves are of epoxy powder-coated steel in grey RAL 7035. Four swivel castors (Ø 100 mm), two of which have brakes.



Size W x D x H mm	Shelf size W x D mm	Max load kg	Code
1090 x 530 x 1515	1000 x 430	150	HCT410

## Carton trolley

Name	Description	Size W x D x H mm	Code
<b>1. Castor Set</b>	Castor set for carton trolley. The castor set gives you a trolley from the SPM-shelf.	600 x 125	SPMCS-41
<b>2. Shelf for packing material</b>	600 mm deep shelf for many purposes. The shelf can also be equipped with PDH600 divider hoops. Max load 60 kg.	467 x 600 x 32	SPM500-49
		717 x 600 x 32	SPM750-49
		870 x 600 x 32	SPM900-49
		1167 x 600 x 32	SPM1200-49
		1317 x 600 x 32	SPM1350-49
		1467 x 600 x 32	SPM1500-49
<b>3. Divider hoops set (4 pcs), SPM-shelf</b>	Divider hoop set for the SPM-shelves. Height 280 mm. The fixed divider is tightened with the screw at the front edge of the shelf.	1773 x 600 x 32	SPM1800-49
		8 x 400 x 280	PDH600-49

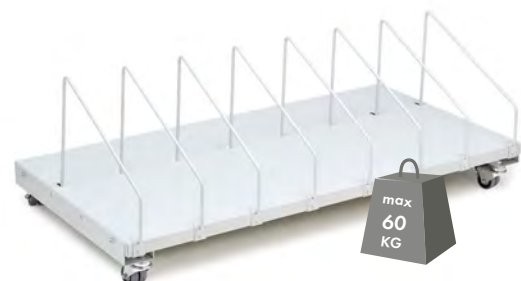

## Industrial multi trolley frame with accessories

Name	Description	Module	Size W x D x H mm	Code
1. <b>Industrial multi trolley frame</b>	Max load 300 kg.	M750	790 x 760 x 1790	TMTFH7-41
		M900	943 x 760 x 1790	TMTFH9-41
2. <b>Shelf for packing material</b>	600 mm deep shelf for many purposes. The shelf can also be equipped with PDH600 divider hoops. Max load 60 kg.		717 x 600 x 32	SPM750-49
			870 x 600 x 32	SPM900-49
3. <b>Brackets for upright tube SPM</b>	Mounting parts for top shelf to the upright tube. With the mounting kit, you attach the SPM shelf to the upright tube.			SPMBS-49
4. <b>Divider hoops set SPM-shelf</b>	Divider hoop set (4 pcs) for the SPM-shelves. Height 280 mm. The fixed divider is tightened with the screw at the front edge of the shelf.		8 x 400 x 280	PDH600-49
5. <b>Aluminium bin rail</b>	For auxiliary steel shelf, stacking and picking bins. Very sturdy. Max load 15 kg.	M750	736 x 55 x 75	BP750C
		M900	889 x 55 x 75	BP900C
6. <b>Tablet bracket MY</b>	Tablet bracket for 7-10" tablets.			MY
<b>LCD bracket MH</b>	The quick-release mechanism is equipped with the standard used flat-screen mount 75 x 75 and 100 x 100 for the mounting of all normal flat screens.			MH
<b>Adapter set</b>	Adapter set for fixing LCD bracket MH to the upright tubes.		200 x 110 x 60	AS2
7. <b>Auxiliary steel shelf</b>	Shelf for A4 paper and tape dispensers (max 2 pcs per shelf). Mounted on bin profile. Max load 3 kg.		217 x 298 x 20	ASSA4
8. <b>Roll holder set</b>	Roll holder set for packing material rolls. Max load 40 kg.	M750		890 547-49P
		M900		890 548-49P
9. <b>Fixed tape dispenser</b>	Feeds tape from a roll; for a tape roll with a 76-mm socket. Includes screws to fix the dispenser to ASSA4. Max roll Ø 120 mm and width 50 mm.			FTD50
10. <b>Basic label dispenser</b>	Feeds labels from a roll, space for several rolls. Fits on ASSA4 or can be placed in a shelf or tray. Can be fixed with screws. Max roll Ø 220 mm and width 210 mm.			BLD20
11. <b>Document holder A4</b>	Steel document holder fixed on upright tube. Easily adjustable with the double arm. Max load 5 kg.			928 49 008P
12. <b>Equipment tray</b>	With double arm and handle. For small tools and packing accessories such as BLD20. Max load 15 kg.		500 x 250 x 125	928 49 002P

Please visit our webpage for full range of module M750 and M900 accessories.

## Recycling material trolley PRMT

The recycling trolleys are ideal for placing underneath or beside the packing bench. The bins are adjustable in angle for ease of use! The trolley comes with four swivel castors, two with brakes. Available in single and double version.

Size W x D x H mm	Code
350 x 625 x 765	PRMT 1
680 x 625 x 765	PRMT 2



Industrial multi trolley frame with accessories

# Heavy-duty trolley

Heavy-duty trolleys, as their name indicates, are ideal for moving heavy loads. Their special castors support extremely heavy weights. The total capacity of the basic model is up to 600 kg!

The heavy-duty trolleys are equipped with two fixed castors (Ø 100 mm) and two swivel castors with brakes.



**Heavy-duty trolley 1**, code C 750 41 001



**Heavy-duty trolley 2**, code C 750 41 002

## Heavy-duty trolleys

Name	Size W x D x H mm	Max load kg	Code
Heavy-duty trolley 1	935 x 785 x 830	600	C 750 41 001
Heavy-duty trolley 2	935 x 785 x 830	600	C 750 41 002

## Heavy-duty trolley accessories

Name	Size W x D x H mm	Max load kg	Code
Shelf	812 x 770 x 30	400	852 671-49

## Heavy-duty trolley 3, code C 750 07 103

Qty	Name	Size mm	Code
1	Bottom shelf	933 x 780	852 666-49
1	Perforated uprights, pair	661	852 668-49
1	Perforated uprights, pair	1359	852 667-49
1	Cross support, pair		852 669-49
1	Handle		852 670-49
1	Pvc-top, steel edges	1000 x 750	836 723-79
2	Fixed castors	Ø100	1988
2	Swivel castors	Ø100	1987
1	Perforated panel	870 x 389	861 516-49
1	Bin rail M900	895	859 152-41
6	Plastic box 1525-5		1525-5
1	Fixing set		870 811-00
1	Drawer unit 53/36	530 x 640 x 360	5336 004-07



**Heavy-duty trolley 3**, code C 750 07 103

Size 1000 x 810 x 1590 mm  
 Top 1000 x 750 mm  
 Worktop height 850 mm

# Fitter's trolley

A fitter's trolley lets you take your supplies and tools wherever you go, while keeping them organised. Rubber mats and ESD-mats for shelves available separately.

The fitter's trolleys are equipped with four swivel castors (Ø 125 mm), two of which have brakes. Fitter's trolley can be combined with all M750 accessories.

## Fitter's trolleys

Name	Module	Size W x D x H mm	Max load kg	Code	Code ESD
Fitter's trolley 1	M750	790 x 760 x 875	300	C730 41 001	C730 49 001
Fitter's trolley 2	M750	790 x 760 x 875	300	C730 41 002	C730 49 002
Fitter's trolley 3	M750	790 x 760 x 875	300	C730 41 003	-
Fitter's trolley, frame	M750	790 x 760 x 875	300	C730 41 000	C730 49 000

## Fitter's trolley accessories

Name	Module	Size W x D x H mm	Max load kg	Code	Code ESD
Lower shelf M750 x 728	M750	710 x 728 x 33	100	TMTLS7-49	
Steel shelf M750 x 650 + brackets	M750	718 x 650 x 33	100	TMTS7-49	
Adjustable shelf M750 x 650	M750	718 x 650 x 37	100	TMTAS7-49	
Adjustable shelf M750 x 650, stepless depth adjustment	M750	718 x 650 x 37	50	TMTSAS7-49	

Fitter's trolleys can be combined with M750 accessories.

## Mats for shelves

Suitability	Module	Size W x D mm	Code	Code ESD
Lower shelf TMTLS7-49	M750	705 x 723	725739-00	725747-00
Steel shelf TMTS7-49	M750	713 x 645	725735-00	725743-00
Adjustable shelf TMTAS7-49 and TMTSAS7-49	M750	678 x 600	860548-00	860318-00

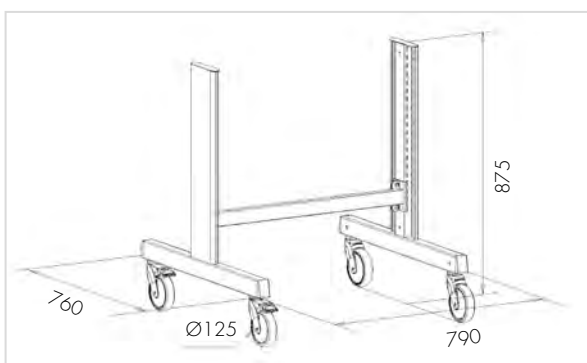

Fitter's trolley frame



Fitter's trolley 1



Fitter's trolley 2



Fitter's trolley 3

Fitter's trolley 3 includes 6 cone racks. Tool holders, page 174, ordered separately.

## Cone rack M750 for tool holders HSK, Capto, ISO

Name	Size W x D x H mm	Max load kg	Code
Cone rack M750	742 x 206 x 95	50	890 729-49

See tool holders on page 180.



Cone rack M750

# Tool trolley

Sturdy tool trolley for workshop and garage environment. Tool trolley is very practical working surface with drawers and cabinets to store tools and components. Push handle and lightly rolling castors makes moving the trolley easy where ever needed. Several combinations available, also as ESD-versions.

The tool trolleys have drawers with actual full opening telescopic ball-race rails. Maximum load 60 kg per drawer and 50 kg per shelf. Two fixed castors and two swivel castors with brakes (Ø100). Steel or vinyl top 910 x 525 x 30 mm.



Tool trolley 1



Tool trolley 2



Tool trolley 3



Tool trolley 4

## Tool Trolley 1

Size W x D x H mm	Max load kg	Code steel top	Code vinyl top	Code ESD steel top ESD
910 x 525 x 880	300	TWIN45-001-41	TWIN45-101-41	TWIN45-201-49

5 fully opening drawers and 1 cabinet. All lockable. Cabinet has 1 height adjustable shelf.

## Tool Trolley 2

Size W x D x H mm	Max load kg	Code steel top	Code vinyl top	Code ESD steel top ESD
910 x 525 x 880	300	TWIN45-002-41	TWIN45-102-41	TWIN45-202-49

2 fully opening drawers and 2 cabinets. All lockable. Both cabinets have 1 height adjustable shelf.

## Tool Trolley 3

Size W x D x H mm	Max load kg	Code steel top	Code vinyl top	Code ESD steel top ESD
910 x 525 x 880	300	TWIN45-003-41	TWIN45-103-41	TWIN45-203-49

8 lockable fully opening drawers.

## Tool Trolley 4

Size W x D x H mm	Max load kg	Code steel top	Code vinyl top	Code ESD steel top ESD
910 x 525 x 880	300	TWIN45-004-41	TWIN45-104-41	TWIN45-204-49

9 lockable fully opening drawers.

**Tool Trolley 5**

Size W x D x H mm	Max load kg	Code steel top	Code vinyl top	Code ESD steel top ESD
910 x 525 x 880	300	TWIN45-005-41	TWIN45-105-41	TWIN45-205-49

4 lockable fully opening drawers and 2 open height adjustable shelves. Shelves with raised edges.



Tool trolley 5

**Perforated panel kit**

Size W x D x H mm	Code
780 x 30 x 685	890 768-49

Practical perforated panel kit for tool hooks can be mounted on tool trolley.

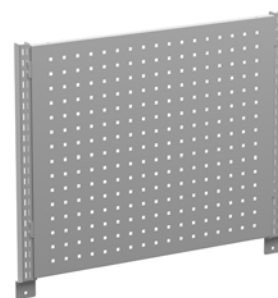

Perforated panel kit

**Drawer interiors for tool trolley****Divider set 1**

Model	Code
Drawer 45/100	872 991-49
Drawer 45/ 150 and 45/200	872996-49
4 x horizontal dividers 375	

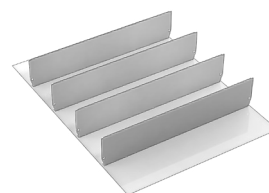
**Divider set 2**

Model	Code
Drawer 45/100	872 992-49
Drawer 45/ 150 and 45/200	872 997-49
1 x vertical divider, 8 x divider plate 185	

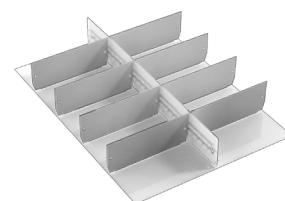
**Divider set 3**

Model	Code
Drawer 45/100	872 993-49
Drawer 45/ 150 and 45/200	872998-49
1 x vertical divider, 4 x divider plate 125, 4 x divider plate 250	

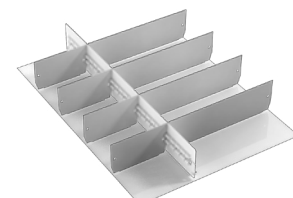
**Divider set 4**

Model	Code
Drawer 45/100	872 994-49
Drawer 45/ 150 and 45/200	8729 99-49
2 x vertical divider, 12 x divider plate 125	

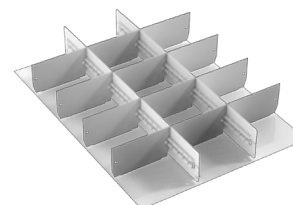

# Stacking bin trolley

A storage system for stores, production facilities and warehouses. It is easily moved to wherever it is needed. You can configure the trolley to match your needs.

- Double-sided trolley for stacking bins
- Powder-coated (light grey, RAL 7035), steel-frame trolley with a fixed bottom shelf
- Up to 112 stacking bins can be attached to one trolley, must be ordered separately
- Four different sizes of stacking bins to choose from
- Height adjustable ergonomic push handle
- Sixteen step-by-step height adjustable bin rails, eight bin rails per side, length of bin rails 742 mm
- Height of the bin rails can be adjusted easily without tools
- Four swivel castors (Ø 100 mm), two with brakes
- Module M750, all the upright tube accessories are available



1 x trolley BT-170B  
40 x blue stacking bin 1520-6  
32 x blue stacking bin 1930-6

## Trolley BT-170B

Size W x D x H mm	Max load kg	Code	Code ESD
790 x 760 x 1770	300*	BT-170B	BT-170B ESD

\*Load capacity for bin rail 50 kg

## Suitable stacking bins

Code	Quantity/rail	Max. quantity/trolley
1015	7 pcs	112 pcs
1520	5 pcs	80 pcs
1525	5 pcs	80 pcs
1930	4 pcs	64 pcs

Details of stacking bins can be found on page 210.

**+** **Add accessories as needed!**  
Accessories starting from page 69. All module M750 accessories suit stacking bin trolley.



Bottle holder Ø 100



Equipment tray



Tool panel

# Cabinet trolley for small-parts storage cabinets

This assembly holds 8 cabinets, which must be ordered separately. This double sided trolley has 4 swivel castors (Ø 100 mm), two of which have brakes. One steel bottom shelf comes as standard. Height-adjustable ergonomic push handle makes the trolley easy to move.

Powder-coated (light grey, RAL 7035) steel frame with a fixed bottom shelf. Height of the fixing rails can be adjusted easily without tools. Module M750, all the upright tube accessories are available for cabinet trolley.

## Trolley BT-550B

Size W x D x H mm	Max load kg	Code	Code ESD
790 x 760 x 1770	300	BT-550B	BT-550B ESD

Maximum eight small-parts cabinets, 4 on each side, to be ordered separately.

## Suitable small-parts storage cabinets

Code	Includes small drawers	Small drawer dimensions W x D x H
550-3	L-00 (60 pcs)	55 x 175 x 37
551-3	L-01 (48 pcs)	69 x 175 x 37
551-4ESD	L-61-4ESD (48 pcs)	69 x 170 x 40
552-3	L-02 (24 pcs)	138 x 175 x 37
554-3	L-04 (24 pcs)	92 x 175 x 59
554-4ESD	L-64-4ESD (24 pcs)	92 x 170 x 62
556-3	L-06 (8 pcs)	277 x 175 x 59
557-3	L-07 (12 pcs)	138 x 175 x 81
550C-3	L-01 (24 pcs)	69 x 175 x 37
	L-04 (6 pcs)	92 x 175 x 59
	L-06 (2 pcs)	277 x 175 x 59

Details of series 550 can be found on page 200.



1 x trolley BT-550B  
8 x small-parts storage cabinets 551-4ESD



### Add accessories as needed!

Here are some examples of accessories suitable for trolley BT-550B. See page 69 for full range of module M750 accessories.



Tablet bracket



Document holder A4



## 6. Drawer units

# Versatile drawer units



We provide a comprehensive range of different drawer units for a variety of purposes. You can fix any drawer unit from the same series under a worktop or on a plinth, or equip them with castors to take along to your next workstation.

## Efficient storage and control

Our drawer units are great for storing tools and supplies. It is surprising how much time is spent finding tools and other items if they are not stored systematically. The versatile interior combinations of our drawer units guarantee that your supplies are always at hand and in good order.

## A comprehensive range of drawer units

We promise that you will find a drawer unit that meets your requirements in our comprehensive range. You can choose from several different heights and drawer and interior combinations. We have selected some combinations for this brochure. For more options, please contact: [sales@treston.com](mailto:sales@treston.com).



Combination name

**45/56-1**

Width Height Version

# Drawer unit 35

These slimline but practical metal drawer units are mounted directly under a workbench to provide more storage. Ideal for workers personal storage. Choose from one-drawer and two-drawer versions, based on how much storage space is needed. Both models are lockable. The units are made from steel and epoxy powder coated in light grey, RAL 7035. Smooth and quiet telescopic ball-race runners with 80 % opening of the drawers. Load-bearing capacity is 10 kg per drawer.

Drawers open  
80% and their  
load capacity is  
10 kg.

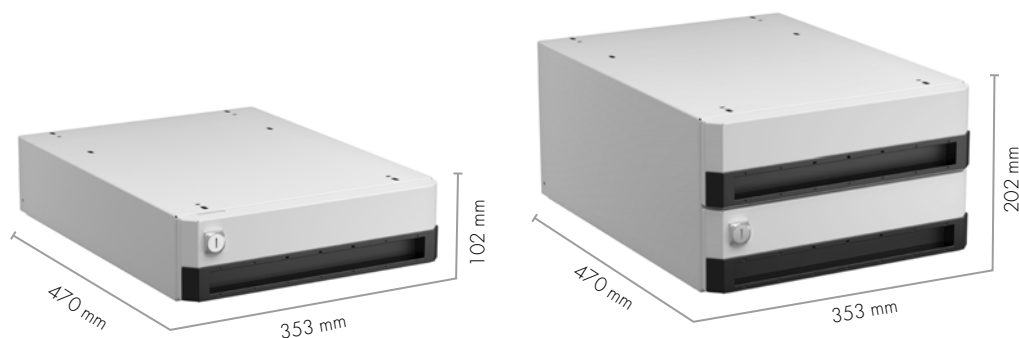

- Choose from one-drawer and two-drawer versions
- All models are ESD protected

Internal drawer dimensions mm	
Width 305	Depth 430
Outer height mm	Inner height mm
100	85

## 1. Drawer unit 35/10

Drawers	Outer dims W x D x H mm	Code ESD
100 x 1	353 x 470 x 102	DU3510-49



## 2. Drawer unit 35/20

Drawers	Outer dims W x D x H mm	Code ESD
100 x 2	353 x 470 x 202	DU3520-49





**Fastening sets for drawer unit 35 (should be selected according to the type of the workbench)**

Depth	600 mm	700 mm	750 mm	800 mm	900 mm
Concept Ergo manual and electric adjustable	855 063-00	-	855 063-00	-	855 063-00
Concept, hand crank adjustable	-	-	855 062-49	-	855 062-49
TED	-	-	-	855 057-49	-
TP / TPH / TPB	-	855 061-49	-	-	855 061-49
WB	-	-	-	855 061-49	-
Treston Quatrex	-	-	855 058-49	-	855 058-49

Not adapted to Concept hand crank adjustable bench depth 600 mm.

# Drawer unit 45

Centrally locked high quality steel drawer units for storage of tools and small components. Mounted under workbenches with brackets. Also available with castors as a trolley version. Drawer units are epoxy powder coated in grey, RAL 7035. Central locking. Full width drawer handle in anodised aluminium. Smooth and quiet telescopic ball-race runners with 100 % opening of the drawers. Load-bearing capacity is 60 kg per drawer. Our drawer units are suitable for use in EPAs. The mobile trolleys are available in both ESD and non- ESD versions.

Drawers open 100% and their load capacity is 60 kg.

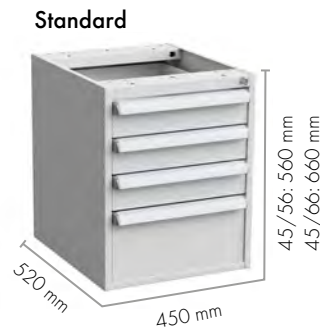

Load capacity 150 kg, 4 swivel castors (ø 100 mm), 2 with brakes. The trolley version comes with a rubber mat that stops items from sliding on the surface.

- Choose the drawer unit according to your needs; with castors, base or no base.
- Drawer units with castors are also available as non ESD-versions (code 41 instead of 49).

Internal drawer dimensions mm	
Width 380	Depth 500
Outer height mm	Inner height mm
100	90
150	140
200	190
300	290

## 1. Drawer unit 45/14-1

Drawers	Code
100 x 1	Standard 603 49 001

## 2. Drawer unit 45/26-1

Drawers	Code
100 x 2	Standard 604 49 001

## 3. Drawer unit 45/56-2

Drawers	Code	Code	Code
	Standard	With base	With castors
100 x 2, 150 x 2	606 49 102	606 49 202	606 49 302

## 4. Drawer unit 45/56-3

Drawers	Code	Code	Code
	Standard	With base	With castors
100 x 3, 200 x 1	606 49 103	606 49 203	606 49 303



**5. Drawer unit 45/66-1**

Drawers	Code	Code	Code
	Standard	With base	With castors
100 x 6	607 49 101	607 49 201	607 49 301



**6. Drawer unit 45/66-2**

Drawers	Code	Code	Code
	Standard	With base	With castors
100 x 3, 150 x 2	607 49 102	607 49 202	607 49 302

**7. Drawer unit 45/66-6**

Drawers	Code	Code	Code
	Standard	With base	With castors
100 x 2, 200 x 2	607 49 106	607 49 206	607 49 306



**8. Drawer unit 45/66-7**

Drawers	Code	Code	Code
	Standard	With base	With castors
200 x 3	607 49 107	607 49 207	607 49 307

**Additional drawer units 45/56**

	45/56-1	45/56-4	45/56-7	45/56-10	45/56-11
Standard	606 49 101	606 49 104	606 49 107	606 49 110	606 49 111
With base	606 49 201	606 49 204	606 49 207	606 49 210	606 49 211
With castors	606 49 301	606 49 304	606 49 307	-	-
100	x 5	x 1	-	x 2	-
150	-	-	x 2	-	-
200	-	x 2	x 1	-	x 1
300	-	-	-	x 1	x 1

**Additional drawer units 45/66**

	45/66-3	45/66-4	45/66-5	45/66-12	45/66-13	45/66-14	45/66-15
Standard	607 49 103	607 49 104	607 49 105	607 49 112	607 49 113	607 49 114	607 49 115
With base	607 49 203	607 49 204	607 49 205	607 49 212	607 49 213	607 49 214	607 49 215
With castors	607 49 303	607 49 304	607 49 305	-	-	-	-
100	x 1	-	x 4	x 3	-	x 1	-
150	x 2	x 4	-	-	x 2	-	-
200	x 1	-	x 1	-	-	x 1	-
300	-	-	-	x 1	x 1	x 1	x 2

**Cabinet 45/56, door right**

	w/o lock	with lock
Standard	606 49 105	606 49 108
With plinth	606 49 205	606 49 208
With castors	606 49 305	606 49 308

**Cabinet 45/56, door left**

	w/o lock	with lock
Standard	606 49 106	606 49 109
With plinth	606 49 206	606 49 209
With castors	606 49 306	606 49 309

Cabinets include one bottom shelf and one adjustable shelf, shelf load capacity 50 kg.

**Drawer cabinet 45/66, door right**

drawer 1 x 100	w/o lock	with lock
Standard	607 49 108	607 49 110
With plinth	607 49 208	607 49 210
With castors	607 49 308	607 49 310

**Drawer cabinet 45/66, door left**

drawer 1 x 100	w/o lock	with lock
Standard	607 49 109	607 49 111
With plinth	607 49 209	607 49 211
With castors	607 49 309	607 49 311

Cabinets include one bottom shelf and one adjustable shelf, shelf load capacity 50 kg.

**Fastening sets for drawer unit 45 (should be selected according to the type of the workbench)**

Depth	600 mm	700 mm	750 mm	800 mm	900 mm
Concept Ergo, manual and electric adjustable	DFCE-49	-	DFCE-49	-	DFCE-49
Concept, hand crank adjustable	-	-	890 653-49	-	890 653-49
TP / TPH / TPB	-	855 055-49*	-	-	855 055-49*
WB	-	-	-	855 055-49*	-
Treston QuatreX	-	-	855 058-49	-	855 058-49

Not adapted to Concept hand crank adjustable bench depth 600 mm.

Drawer unit 45/66 is not suitable for electric adjustable benches due to its height.

For heavy loads we recommend adding a plinth or castors to the drawer unit.

\* Standard drawer unit models include fastening set. For drawer unit models with plinth the fastening set 855 055-49 is available only upon order.

**Cover**

Description	Code
Needed for mounting drawer unit 45 to WB benches.	855 060-49

**Pencil box**

Description	Code
Add a pencil box in the drawer to organise small items more efficiently. Cannot be used together with the drawer divider sets.	854 850-49

**Hanging file support for 45/300 drawer**

Size (inner) W x D x H mm	Code
327 x 492 x 150	W872245-49



# Drawer interiors

## Divider set 1

Model	Code
Drawer 45/100	872 991-49
Drawer 45/ 150 and 45/200	872 996-49
4 x horizontal dividers 375	

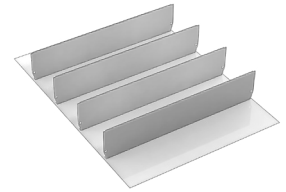

## Divider set 2

Model	Code
Drawer 45/100	872 992-49
Drawer 45/ 150 and 45/200	872 997-49
1 x vertical divider, 8 x divider plate 185	

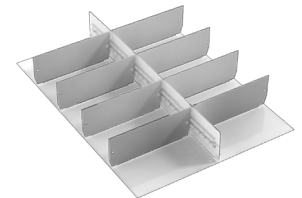

## Divider set 3

Model	Code
Drawer 45/100	872 993-49
Drawer 45/ 150 and 45/200	872 998-49
1 x vertical divider, 4 x divider plate 125, 4 x divider plate 250	

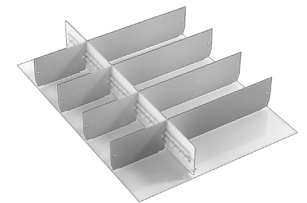

## Divider set 4

Model	Code
Drawer 45/100	872 994-49
Drawer 45/ 150 and 45/200	872 999-49
2 x vertical divider, 12 x divider plate 125	

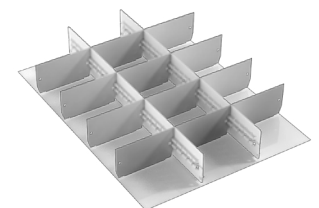

For additional divider parts see page 219.

Drawer units with castors are also available as non ESD-versions (code 41 instead of 49).



# Drawer unit 53

With these heavy-duty drawer units you can optimise your storage and keep all your items perfectly organised. The safety locking prevents other drawers from opening while one drawer is open (always lock the drawers with key during transport). You can choose the best option from three heights to meet your needs, or add height or width with different drawer unit combinations.

The units with base can also be used as workbench legs on Heavy duty workbench and the smaller drawers are easily fastened under a workbench. The drawer unit with castors has pulling handle and top with rubber mat. It is an excellent choice for a mobile workstation. The version with doors is ideal for storing larger items.

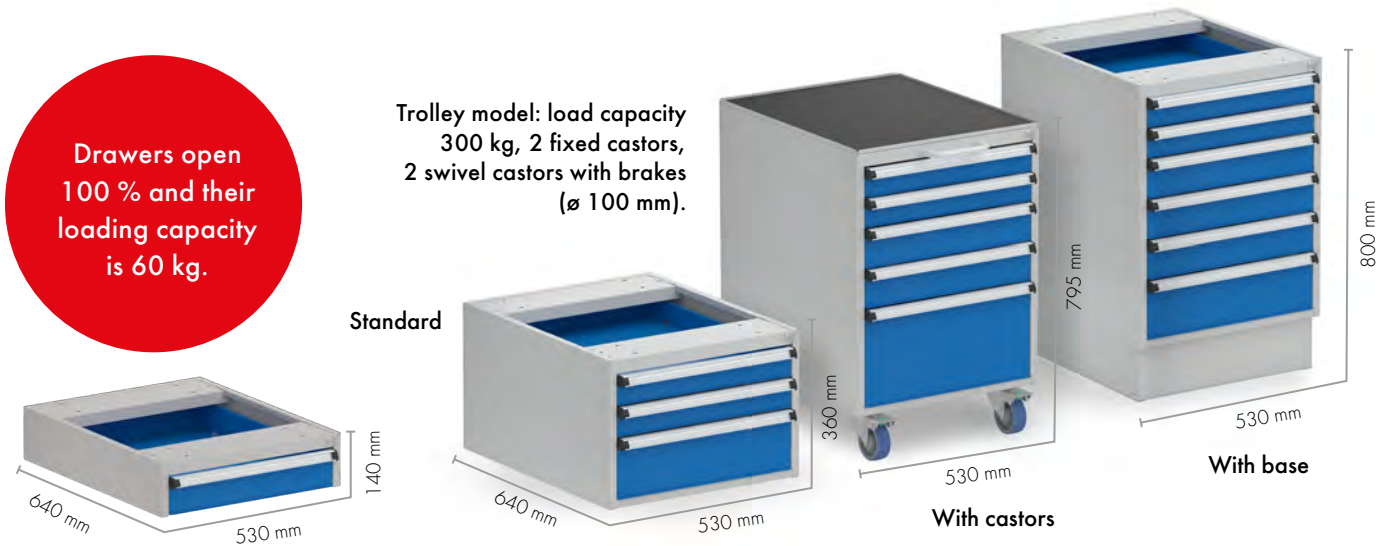

- Choose the drawer unit according to your needs; with castors, base or no base.
- Also available as grey ESD-versions (code 49 instead of 07)
- Drawers open 100 % and their loading capacity is 60 kg.

Internal drawer dimensions mm	
Width 460	Depth 612
Outer height mm	Inner height mm
75	60
100	85
150	135
250	235

### 1. Drawer unit 53/14-1

Drawers	Code
100 x 1	Standard 5314 001-07

### 2. Drawer unit 53/36-4

Drawers	Code
75 x 2, 150 x 1	Standard 5336 004-07

### 3. Drawer unit 53/36-2

Drawers	Code
100 x 3	Standard 5336 002-07

### 4. Drawer unit 53/66-1 (black)

Drawers	Code Standard	Code With base	Code With castors
75 x 2, 100 x 2, 250 x 1	5366 101-18	5366 201-18	5366 301-18



**5. Drawer unit 53/66-2**

Drawers	Code Standard	Code With base	Code With castors
75 x 2, 100 x 3, 150 x 1	5366 102-07	5366 202-07	5366 302-07

**6. Drawer unit 53/66-4**

Drawers	Code Standard	Code With base	Code With castors
75 x 4, 100 x 3	5366 104-07	5366 204-07	5366 304-07

**7. Drawer unit 53/66-9**

Drawers	Code Standard	Code With base	Code With castors
100 x 3, 150 x 2	5366 109-07	5366 209-07	5366 309-07

**8. Drawer unit 53/66-8**

Drawers	Code Standard	Code With base	Code With castors
100 x 6	5366 108-07	5366 208-07	5366 308-07



Drawer unit 53/66 with base is also available with top (726258-49), rubber mat (723124-00) and ESD mat (726516-49).

**Additional drawer units 53**

	53/36-1	53/36-3	53/66-6	53/66-7	53/66-10	53/66-12
Standard	5336 001-07	5336 003-07	5366 106-07	5366 107-07	5366 110-07	5366 112-07
With base	-	-	5366 206-07	5366 207-07	5366 210-07	5366 212-07
With castors	-	-	5366 306-07	5366 307-07	5366 310-07	5366 312-07
75	4	-	6	8	-	-
100	-	-	-	-	2	-
150	-	2	1	-	1	4
250	-	-	-	-	1	-



**More drawer units in our website**

Kindly visit Treston website for additional drawer unit 53 models:  
[treston.com/drawers/drawer-unit-53](http://treston.com/drawers/drawer-unit-53)

**Drawer unit 53/66-13 and 53/66-14 with door**

	Code Door right	Code Door left
Standard	5366 113-07	5366 114-07
With base	5366 213-07	5366 214-07
With castors	5366 313-07	5366 314-07

Cabinets include bottom shelf and one height adjustable shelf.



Door right



Door left

# Drawer interiors

**Divider Set 1**

Model	Code
53/100	873 001-49
53/150&250	873 006-49

3 dividers, 12 middleplates (9x100, 3x150)

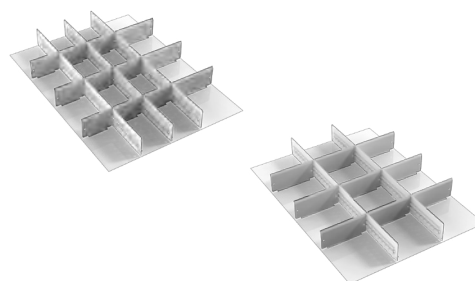

**Divider Set 2**

Model	Code
53/100	873 002-49
53/150&250	873 007-49

2 dividers, 9 middle plates (9x150)

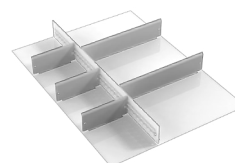

**Divider Set 3**

Model	Code
53/100	873 003-49
53/150&250	873 008-49

1 divider, 5 middle plates (3x150, 2x300)

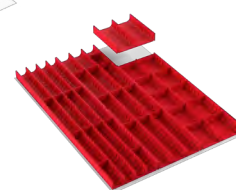

**Tool troughs, 33, 45 and 70 mm wide**

Model	Code
Drawer 53/75	834 122-00

4 x 33 mm, 3 x 45 mm, 2 x 70 mm

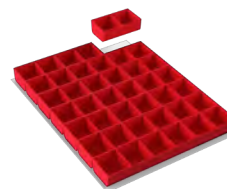

**Pick up boxes**

Model	Code
Drawer 53/75&100	851 866-00

Includes 21 pick-up boxes (149 x 85 x 48 mm) with dividers.



One example of interior solutions shown in picture.

**Rubber mat for the drawer bottom**

Model	Code
Rubber mat 53	852 717-00

**+**

For additional divider parts see page 219.

# Drawer unit 53 combinations

It is possible to combine two drawer unit 53 frames with the help of a TWIN set (combination 5). The middle plate can be used to stack two drawer units 53 (combinations 1-4).

## Combination 1, Code C53001-07

Includes	Code
53/66-1	5366 301-07
53/36-4	5336 004-07
Middle plate	854 109-49

## Combination 2, Code C53002-07

Includes	Code
53/66-13	5366 313-07
53/36-4	5336 004-07
Middle plate	854 109-49

## Combination 3, Code C53003-07

Includes	Code
53/66-1	5366 201-07
53/36-4	5336 004-07
Middle plate	854 109-49

## Combination 4, Code C53004-07

Includes	Code
53/66-13	5366 213-07
53/36-4	5336 004-07
Middle plate	854 109-49

## Combination 5, Code C53005-07

Includes	Size mm	Code
53/66-13		5366 113-07
53/66-1		5366 101-07
Twin set		854 108-41
Bench top	1200 x 750 x 40	110 995-79

## TWIN set

Name	Size mm	Code
Twin set		854 108-41
Bench top	1200 x 750 x 40	110 995-79

The Twin set includes four swivel castors Ø100 mm, two of which have brakes and plates to fix two frames together. The top is not included in the pack.



**Note!** Combinations 1-5 have serialized locks. For other combinations serialization can be ordered.

Always remember to lock the drawer unit during transport!

# Drawer units 70, 90 and 130

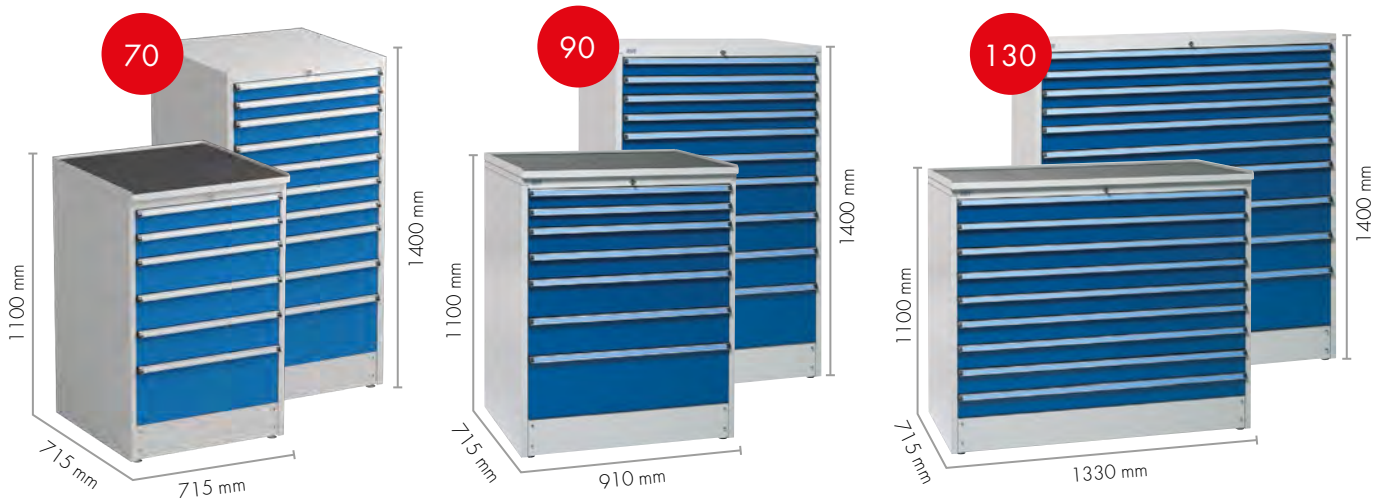

You can fit an amazing number of things in these spacious drawer units. Choose the one that best meets your needs from two heights: 110 and 140 cm. The 110-cm-high drawer units include a cover that doubles as a worktop with a rubber mat.

The safety locking prevents other drawers from opening while one drawer is open. The drawer unit can be moved with a pallet truck or a forklift when the base front plate has been removed. The drawers are fully opening and their load capacity is up to 200 kg.

Drawer units 70, 90 and 130 are also available in grey (code 41 instead of 07, e.g. 613 41 004).



Some drawer units are also available in black. Explore the range on our website.



All the drawers are fully opening, also available with a load capacity of up to 200 kg!

The drawer units 70, 90 and 130 all have fully opening drawers. The load capacity of the standard drawers is 75 kg, but all the drawer units are available with drawers that have **a load capacity of 200 kg!**

The drawer units with the load capacity of 200 kg are indicated by a product code having an H in the end (e.g. 613 07 001 H).

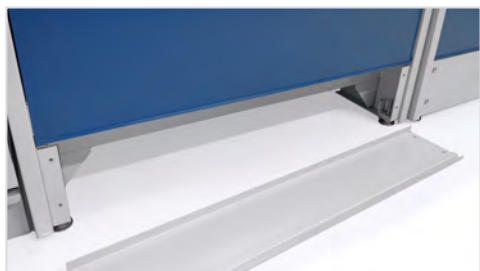

The drawer units 70, 90 and 130 can be moved with a pallet truck or a forklift when the base front plate has been removed.



The large drawer units 70, 90 and 130 include levelling screws, which help to level the unit on uneven surfaces.

# Drawer unit 70



Drawers open 100% and their load capacity is 75 kg or 200 kg.

Internal drawer dimensions mm	
Width 612	Depth 612
Outer height mm	Inner height mm
75	49
100	74
150	124
250	224

## 1. Drawer unit 70/110-4

Drawers	Code	Code
	75 kg	200 kg
75 x 2, 100 x 2, 150 x 2, 250 x 1	613 07 004	613 07 004 H

## 2. Drawer unit 70/110-4 (black)

Drawers	Code	Code
	75 kg	200 kg
75 x 2, 100 x 2, 150 x 2, 250 x 1	613 18 004	613 18 004 H

## 3. Drawer unit 70/110-12 (grey)

Drawers	Code	Code
	75 kg	200 kg
75 x 2, 100 x 6, 150 x 1	613 41 012	613 41 012 H

## 4. Drawer unit 70/110-45

Drawers	Code	Code
	75 kg	200 kg
100 x 4, 250 x 2	613 07 045	613 07 045 H

## 5. Drawer unit 70/140-1

Drawers	Code	Code
	75 kg	200 kg
75 x 2, 100 x 5, 150 x 2, 250 x 1	616 07 001	616 07 001 H

## 6. Drawer unit 70/140-3

Drawers	Code	Code
	75 kg	200 kg
100 x 4, 150 x 2, 250 x 2	616 07 003	616 07 003 H



**7. Drawer unit 70/140-4**

Drawers	Code 75 kg	Code 200 kg
75 x 4, 100 x 2, 150 x 3, 250 x 1	616 07 004	616 07 004 H

**8. Drawer unit 70/140-19**

Drawers	Code 75 kg	Code 200 kg
75 x 16	616 07 019	616 07 019 H

**9. Drawer unit 70/140-23**

Drawers	Code 75 kg	Code 200 kg
100 x 8, 150 x 1, 250 x 1	616 07 023	616 07 023 H

**10. Drawer unit 70/140-31**

Drawers	Code 75 kg	Code 200 kg
100 x 9, 150 x 2	616 07 031	616 07 031 H

**Additional drawer units 70/110**

	70/110-1	70/110-2	70/110-3	70/110-13	70/110-20	70/110-21	70/110-32	70/110-33
Code (75 kg)	613 07 001	613 07 002	613 07 003	613 07 013	613 07 020	613 07 021	613 07 032	613 07 033
Code (200 kg)	613 07 001 H	613 07 002 H	613 07 003 H	613 07 013 H	613 07 020 H	613 07 021 H	613 07 032 H	613 07 033 H
75	-	x 2	-	-	x 8	-	x 12	-
100	x 2	x 3	x 9	x 6	x 3	-	-	x 1
150	x 3	x 3	-	x 2	-	x 1	-	x 2
250	x 1	-	-	-	-	x 3	-	x 2

**Additional drawer units 70/140**

	70/140-2	70/140-14	70/140-20	70/140-24	70/140-26	70/140-28	70/140-36	70/140-37
Code (75 kg)	616 07 002	616 07 014	616 07 020	616 07 024	616 07 026	616 07 028	616 07 036	616 07 037
Code (200 kg)	616 07 002 H	616 07 014 H	616 07 020 H	616 07 024 H	616 07 026 H	616 07 028 H	616 07 036 H	616 07 037 H
75	x 2	-	-	-	x 10	x 6	x 6	x 2
100	x 6	x 6	x 3	x 12	x 3	x 3	x 2	-
150	x 3	x 4	x 6	-	x 1	x 3	x 2	x 2
250	-	-	-	-	-	-	x 1	x 3



More drawer units in our website

Kindly visit Treston website for additional drawer unit 70 models:  
[treston.com/drawers/drawer-unit-70](http://treston.com/drawers/drawer-unit-70)

# Drawer interiors

## Tool troughs, 33 and 45 mm wide

Name	Code
Drawer 70/50	837 911-00
Drawer 70/75	837 911-00
8 x 33 mm, 6 x 45 mm	

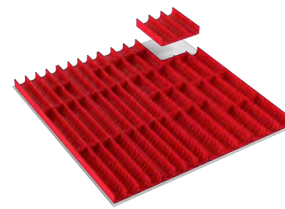

## Tool troughs, 45 and 70 mm wide

Name	Code
Drawer 70/50	837 938-00
Drawer 70/75	837 938-00
6 x 45 mm, 4 x 70 mm	

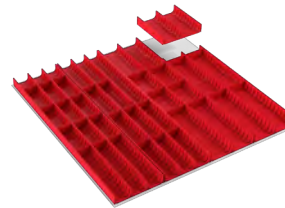

## Pick up boxes

Name	Code
Drawer 70/75	851 867-00
Includes 28 pick-up boxes (149 x 85 x 48 mm) with dividers.	

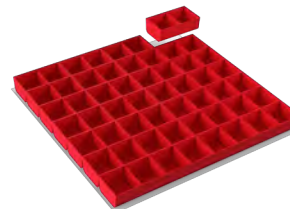

## Divider Set 1

Name	Code
70/75	873 011-49
70/100	873 021-49
70/150 & 250	873 031-49
5 dividers, 18 middle plates (18x100)	

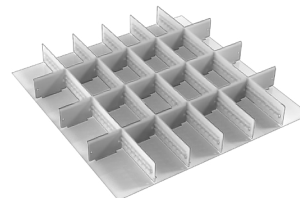

## Divider Set 2

Name	Code
70/75	873 012-49
70/100	873 022-49
70/150 & 250	873 032-49
3 dividers, 12 middle plates (12x150)	

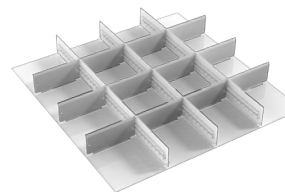

## Divider Set 3

Name	Code
70/75	873 013-49
70/100	873 023-49
70/150 & 250	873 033-49
1 divider, 4 middle plates (4x300)	



One example of interior solutions shown in picture.

**Divider Set 4**

Name	Code
70/75	873 014-49
70/100	873 024-49
70/150 & 250	873 034-49
4 dividers, 15 middle plates (9x100, 6x150)	

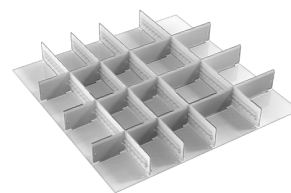
**Divider Set 5**

Name	Code
70/75	873 015-49
70/100	873 025-49
70/150&250	873 035-49
2 dividers, 8 middle plates (6x150, 2x300)	

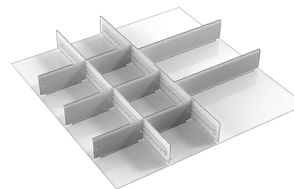
**Divider Set 6**

Name	Code
70/75	873 016-49
70/100	873 026-49
70/150&250	873 036-49
3 dividers, 11 middle plates (9x100, 2x300)	

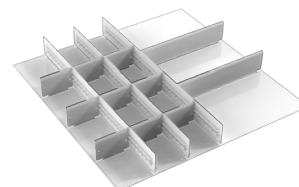
**Rubber mat for the drawer bottom**

Name	Code
Rubber mat 70	852 718-00



For additional divider parts see page 219.

# Drawer unit 90



Drawers open 100% and their load capacity is 75 kg or 200 kg.

Internal drawer dimensions mm	
Width 810	Depth 612
Outer height mm	Inner height mm
75	49
100	74
150	124
250	224

## 1. Drawer unit 90/110-4

Drawers	Code	Code
	75 kg	200 kg
75 x 2, 100 x 2, 150 x 2, 250 x 1	614 07 004	614 07 004 H

## 2. Drawer unit 90/110-4 (black)

Drawers	Code	Code
	75 kg	200 kg
75 x 2, 100 x 2, 150 x 2, 250 x 1	614 18 004	614 18 004 H



## 3. Drawer unit 90/110-2 (grey)

Drawers	Code	Code
	75 kg	200 kg
75 x 2, 100 x 3, 150 x 3	614 07 002	614 07 002 H

## 4. Drawer unit 90/110-13

Drawers	Code	Code
	75 kg	200 kg
100 x 6, 150 x 2	614 07 013	614 07 013 H



## 5. Drawer unit 90/110-33

Drawers	Code	Code
	75 kg	200 kg
100 x 1, 150 x 2, 250 x 2	614 07 033	614 07 033 H

## 6. Drawer unit 90/110-34

Drawers	Code	Code
	75 kg	200 kg
150 x 6	614 07 034	614 07 034 H



**7. Drawer unit 90/140-1**

Drawers	Code 75 kg	Code 200 kg
75 x 2, 100 x 5, 150 x 2, 250 x 1	617 07 001	617 07 001 H

**8. Drawer unit 90/140-3**

Drawers	Code 75 kg	Code 200 kg
100 x 4, 150 x 2, 250 x 2	617 07 003	617 07 003 H





**9. Drawer unit 90/140-4**

Drawers	Code 75 kg	Code 200 kg
75 x 4, 100 x 2, 150 x 3, 250 x 1	617 07 004	617 07 004 H





**10. Drawer unit 90/140-19**

Drawers	Code 75 kg	Code 200 kg
75 x 16	617 07 019	617 07 019 H

**Additional drawer units 90/110**

	90/110-1	90/110-3	90/110-20	90/110-21	90/110-43	90/110-44	90/110-45	90/110-46
Code (75 kg)	614 07 001	614 07 003	614 07 020	614 07 021	614 07 043	614 07 044	614 07 045	614 07 046
Code (200 kg)	614 07 001 H	614 07 003 H	614 07 020 H	614 07 021 H	614 07 043 H	614 07 044 H	614 07 045 H	614 07 046 H
 75	-	-	x 8	-	x 2	-	-	x 8
 100	x 2	x 9	x 3	-	-	x 3	x 4	-
 150	x 3	-	-	x 1	-	x 4	-	x 2
 250	x 1	-	-	x 3	x 3	-	x 2	-

**Additional drawer units 90/140**

	90/140-2	90/140-14	90/140-23	90/140-24	90/140-26	90/140-28	90/140-31	90/140-34
Code (75 kg)	617 07 002	617 07 014	617 07 023	617 07 024	617 07 026	617 07 028	617 07 031	617 07 034
Code (200 kg)	617 07 002 H	617 07 014 H	617 07 023 H	617 07 024 H	617 07 026 H	617 07 028 H	617 07 031 H	617 07 034 H
 75	x 2	-	-	-	x 10	x 6	-	-
 100	x 6	x 6	x 8	x 12	x 3	x 3	x 9	-
 150	x 3	x 4	x 1	-	x 1	x 3	x 2	x 8
 250	-	-	x 1	-	-	-	-	-



More drawer units in our website

Kindly visit Treston website for additional drawer unit 90 models:  
[treston.com/drawers/drawer-unit-90](https://treston.com/drawers/drawer-unit-90)

# Drawer interiors

## Tool troughs, 33 and 45 mm wide

Name	Code
Drawer 90/75	837 913-00
8 x 33 mm, 9 x 45 mm	
Tool troughs leave 50 mm free space on one side of the drawer.	

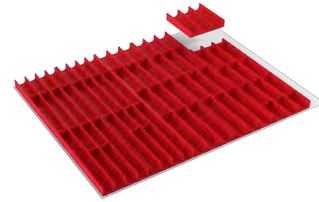

## Tool troughs, 45 and 70 mm wide

Name	Code
Drawer 90/75	837 914-00
9 x 45 mm, 4 x 70 mm	
Tool troughs leave 50 mm free space on one side of the drawer.	

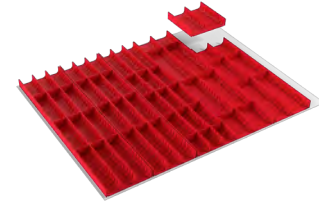

## Pick up boxes

Name	Code
Drawer 90/75	851 870-00
Includes 35 pick-up boxes (149 x 85 x 48 mm) with dividers.	

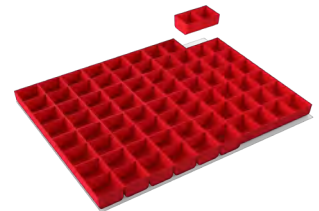

## Divider Set 1

Name	Code
90/75	873 041-49
90/100	873 051-49
90/150 & 250	873 061-49
7 dividers, 24 middle plates (24x100)	

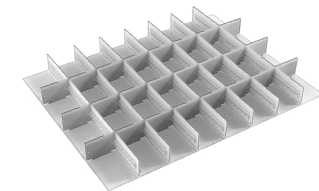

## Divider Set 2

Name	Code
90/75	873 042-49
90/100	873 052-49
90/150 & 250	873 062-49
6 dividers, 21 middle plates (15x100, 6x150)	

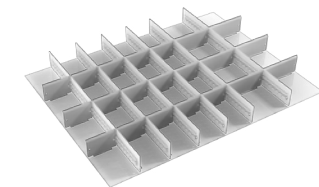

## Divider Set 3

Name	Code
90/75	873 043-49
90/100	873 053-49
90/150 & 250	873 063-49
5 dividers, 17 middle plates (15x100, 2x300)	

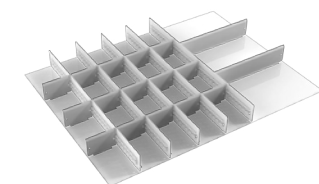

**Divider Set 4**

Name	Code
90/75	873 044-49
90/100	873 054-49
90/150 & 250	873 064-49
4 dividers, 14 middle plates (6x100, 6x150, 2x300)	

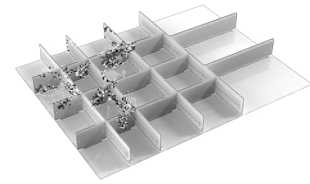
**Divider Set 5**

Name	Code
90/75	873 045-49
90/100	873 055-49
90/150 & 250	873 065-49
3 dividers, 10 middle plates (6x100, 4x300)	

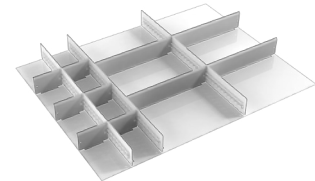
**Divider Set 6**

Name	Code
90/75	873 046-49
90/100	873 056-49
90/150 & 250	873 066-49
5 dividers, 18 middle plates (6x100, 12x150)	

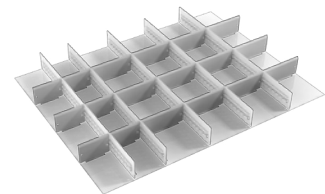
**Divider Set 7**

Name	Code
90/75	873 047-49
90/100	873 057-49
90/150 & 250	873 067-49
4 middle plates (4x800)	

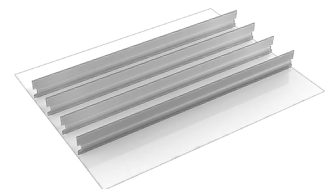
**Rubber mat for the drawer bottom**

Name	Code
Rubber mat 90	854 080-00



For additional divider parts see page 219.

# Drawer unit 130

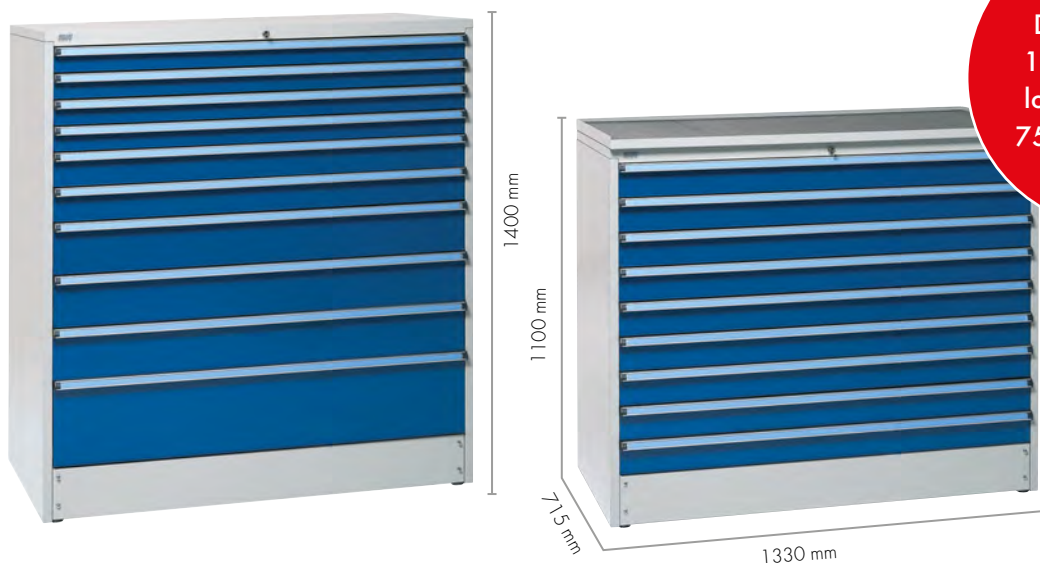

Drawers open 100% and their load capacity is 75 kg or 200 kg.

Internal drawer dimensions mm	
Width 1226	Depth 612
Outer height mm	Inner height mm
75	49
100	74
150	124
250	224

### 1. Drawer unit 130/110-1

Drawers	Code	Code
	75 kg	200 kg
100 x 2, 150 x 3, 250 x 1	615 07 001	615 07 001 H



### 2. Drawer unit 130/110-3

Drawers	Code	Code
	75 kg	200 kg
100 x 9	615 07 003	615 07 003 H

### 3. Drawer unit 130/110-4

Drawers	Code	Code
	75 kg	200 kg
75 x 2, 100 x 2, 150 x 2, 250 x 1	615 07 004	615 07 004 H



### 4. Drawer unit 130/110-4 (grey)

Drawers	Code	Code
	75 kg	200 kg
75 x 2, 100 x 2, 150 x 2, 250 x 1	615 41 004	615 41 004 H

### 5. Drawer unit 130/110-34

Drawers	Code	Code
	75 kg	200 kg
150 x 6	615 07 034	615 07 034 H



### 6. Drawer unit 130/140-1

Drawers	Code	Code
	75 kg	200 kg
75 x 2, 100 x 5, 150 x 2, 250 x 1	618 07 001	618 07 001 H

**7. Drawer unit 130/140-19**

Drawers	<b>Code</b> 75 kg	<b>Code</b> 200 kg
75 x 16	618 07 019	618 07 019 H

**8. Drawer unit 130/140-31**

Drawers	<b>Code</b> 75 kg	<b>Code</b> 200 kg
100 x 9, 150 x 2	618 07 031	618 07 031 H

**9. Drawer unit 130/140-34**

Drawers	<b>Code</b> 75 kg	<b>Code</b> 200 kg
150 x 8	618 07 034	618 07 034 H

**10. Drawer unit 130/140-42**

Drawers	<b>Code</b> 75 kg	<b>Code</b> 200 kg
100 x 1, 150 x 4, 250 x 2	618 07 042	618 07 042 H



**Additional drawer units 130/110**

	130/110-2	130/110-13	130/110-20	130/110-21	130/110-33	130/110-43	130/110-44	130/110-45
<b>Code (75 kg)</b>	615 07 002	615 07 013	615 07 020	615 07 021	615 07 033	615 07 043	615 07 044	615 07 045
<b>Code (200 kg)</b>	615 07 002 H	615 07 013 H	615 07 020 H	615 07 021 H	615 07 033 H	615 07 043 H	615 07 044 H	615 07 045 H
75	x 2	-	x 8	-	-	x 2	-	-
100	x 3	x 6	x 3	-	x 1	-	x 3	x 4
150	x 3	x 2	-	x 1	x 2	-	x 4	-
250	-	-	-	x 3	x 2	x 3	-	x 2

**Additional drawer units 130/140**

	130/140-2	130/140-3	130/140-4	130/140-23	130/140-24	130/140-26	130/140-28	130/140-35
<b>Code (75 kg)</b>	618 07 002	618 07 003	618 07 004	618 07 023	618 07 024	618 07 026	618 07 028	618 07 035
<b>Code (200 kg)</b>	618 07 002 H	618 07 003 H	618 07 004 H	618 07 023 H	618 07 024 H	618 07 026 H	618 07 028 H	618 07 035 H
75	x 2	-	x 4	-	-	x 10	x 6	x 8
100	x 6	x 4	x 2	x 8	x 12	x 3	x 3	x 6
150	x 3	x 2	x 3	x 1	-	x 1	x 3	-
250	-	x 2	x 1	x 1	-	-	-	-



**More drawer unit in our website**

Kindly visit Treston website for additional drawer unit 130 models:  
[treston.com/drawers/drawer-unit-130](http://treston.com/drawers/drawer-unit-130)

# Drawer interiors

## Divider Set 1

Name	Code
130/75	873 071-49
130/100	873 081-49
130/150 & 250	873 091-49
11 dividers, 36 middle plates (36x100)	

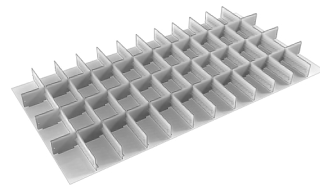

## Divider Set 2

Name	Code
130/75	873 072-49
130/100	873 082-49
130/150 & 250	873 092-49
9 dividers, 30 middle plates (18x100, 12x150)	

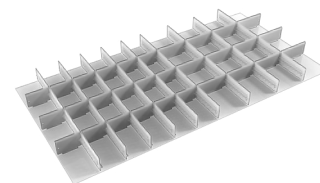

## Divider Set 3

Name	Code
130/75	873 073-49
130/100	873 083-49
130/150 & 250	873 093-49
7 dividers, 22 middle plates (18x100, 4x300)	

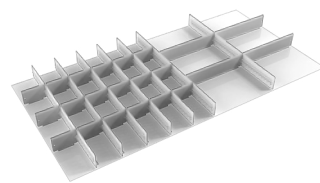

## Divider Set 4

Name	Code
130/75	873 074-49
130/100	873 084-49
130/150 & 250	873 094-49
7 dividers, 23 middle plates (9x100, 12x150, 2x300)	

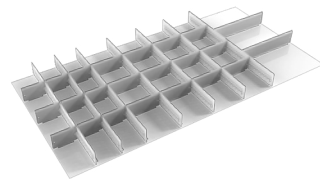

## Divider Set 5

Name	Code
130/75	873 075-49
130/100	873 085-49
130/150 & 250	873 095-49
7 dividers, 16 middle plates (16x150)	

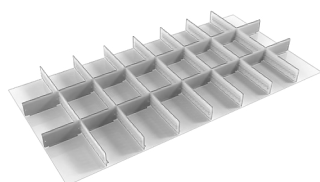

## Divider Set 6

Name	Code
130/75	873 076-49
130/100	873 086-49
130/150 & 250	873 096-49
5 dividers, 16 middle plates (12x150, 4x300)	

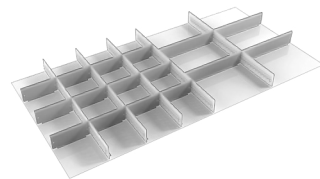

\* One example of interior solutions shown in picture.

**Divider Set 7**

Name	Code
130/75	873 077-49
130/100	873 087-49
130/150 & 250	873 097-49
3 dividers, 12 middle plates (12x300)	

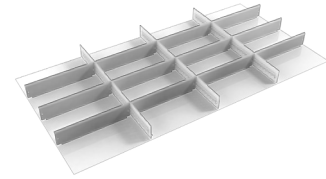
**Divider Set 8**

Name	Code
130/75	873 078-49
130/100	873 088-49
130/150 & 250	873 098-49
4 middle plates (4x1200)	

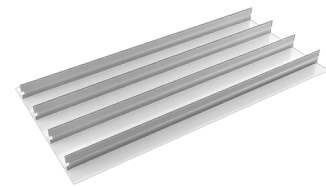
**Tool troughs, 33 and 45 mm wide**

Name	Code
Drawer 130/75	837 912-00
16 x 33 mm, 12 x 45 mm	

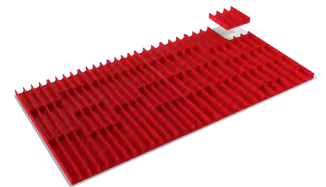
**Tool troughs, 45 and 70 mm wide**

Name	Code
Drawer 130/75	837 939-00
12 x 45 mm, 8 x 70 mm	

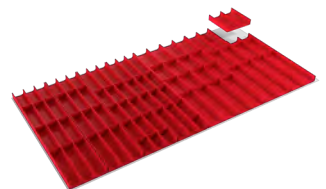
**Pick up boxes**

Name	Code
Drawer 130/75	851 872-00
Includes 56 pick-up boxes (149 x 85 x 48 mm) with dividers.	

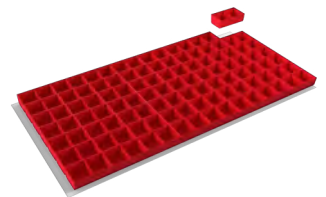
**Rubber mat for the drawer bottom**

Name	Code
Rubber mat 130	854 082-00



For additional divider parts see page 219.



## 7. Storage systems

# Shelves and cabinets



**Modular shelving unit, shelf, and cabinet options help create efficient and functional storage for industrial and technical environments. A wide range of accessories helps customise the storage solution to meet the user's specific needs. A neat work environment improves work pace and safety at work.**

## **Cabinets help keep items in good condition**

In a lockable cabinet, valuable tools, devices, and small items can be kept in their designated places, protected from dirt and dust. The locking systems to choose from include a traditional lock with a key and wire pull, or a locking handle, in which the key is only needed to lock the cabinet.

In industrial cabinets and shelving cabinets, the minimum load capacity of the shelves is always 150 kg, and leg tips enable the cabinets to stand firmly on an uneven surface. These cabinets are always delivered assembled. The cabinets for industrial shelving systems and heavy storage systems are delivered unassembled. All the cabinet models can also be provided with ESD protection.

## **Modular shelving grows with the operations**

The Treston industrial shelving system is based on standard parts, extension parts, doors, perforated panels, and other extra supplies, which can be added and combined to create efficient, comprehensive solutions to meet different storage needs. The shelving system's cabinets are always freestanding, and they can serve as individual storage units.

The robust Treston heavy-duty shelving system is designed specifically for environments in which shelving needs to be strong enough to withstand heavy-duty wear. The heavy-duty shelving system offers versatile, comprehensive storage. A shelving system can be built according to the user's own needs using the standard parts. The maximum load capacity of an individual shelf is 400 kg, which means that almost anything can be put on the shelf and it will not buckle under the load.



600 kg



1000 kg



**Shelving cabinets,**  
page 169

Basic storage is easy and effortless with a shelving cabinet. The shelving cabinets are pre-assembled. The cabinet has sturdy double leaf-doors, flush fitting handle with two keys.

**Industrial cabinets,**  
page 172

Sturdy, quality storage cabinets provide storage suitable for industrial and technical environments, and with a wide range of accessories it can be easily customized into versatile storage solutions.

**Personal safety and computer cabinets,**  
page 175

Cabinets protect equipment from dust and dirt, even in the most demanding conditions.



1000 kg



2000 kg

**Shelving system,**  
page 176

A versatile shelving system that meets nearly all storage needs. Can be assembled to meet individual needs by combining shelves and shelving system cabinets, and by adding accessories as needed.

**Heavy shelving system,**  
page 179

A shelving system that stands firm under the toughest of conditions. A shelving unit can be built from cabinets, drawers, and shelves, and it can have either open or solid sides.

# Shelving cabinets



600 kg  
150 kg/shelf

Basic storage is easy and effortless with a shelving cabinet. Shelves included; additional shelves, perforated panels and drawers are also available. There are leveling screws under the cabinet for adjusting the cabinet straight. The cabinet has sturdy double leaf-doors, flush fitting handle with two keys. The shelving cabinet is delivered assembled.

Shelving cabinets are made of epoxy powder coated steel. The frames are painted with light grey RAL 7035 and doors either with blue RAL5007 or with light grey RAL7035.

## Shelving cabinets with 2 shelves

Size W x D x H mm	Max load kg	Code blue doors	Code ESD grey doors
1030 x 430 x 1040	300	SC10040100-07	SC10040100-49
1030 x 530 x 1040	300	SC10050100-07	SC10050100-49

For additional drawers, shelves and perforated panel see page 171.



## Shelving cabinets with 4 shelves

Size W x D x H mm	Max load kg	Code blue doors	Code ESD grey doors
1030 x 430 x 2010	600	SC10040200-07	SC10040200-49
1030 x 530 x 2010	600	SC10050200-07	SC10050200-49
1030 x 630 x 2010	600	SC10060200-07	SC10060200-49

For additional drawers, shelves and perforated panel see page 171.



## Shelving cabinets with 4 shelves and plexiglass doors

Size W x D x H mm	Max load kg	Code blue doors	Code grey doors
1030 x 430 x 2010	600	SC10040200-07-TD	SC10040200-41-TD
1030 x 530 x 2010	600	SC10050200-07-TD	SC10050200-41-TD
1030 x 630 x 2010	600	SC10060200-07-TD	SC10060200-41-TD

For additional drawers, shelves and perforated panel see page 171.



### Move with a pallet truck

The cabinet can be moved with a pallet truck or a forklift when the plinth front panel has been removed. Cabinets are equipped with leveling screws.



**Shelving cabinet 100/50/200 with accessories**

Size W x D x H mm	Max load kg	Code blue doors	Code ESD grey doors
1030 x 530 x 2010	600	SC10050214-07	SC10050214-49

Includes 3 shelves and 2 perforated panels. For additional drawers, shelves and perforated panel see page 171.



**Shelving cabinet 100/50/200 with accessories**

Size W x D x H mm	Max load kg	Code blue doors	Code ESD grey doors
1030 x 530 x 2010	600	SC10050215-07	SC10050215-49

Includes 2 shelves, 2 drawers and 2 perforated panels. For additional drawers, shelves and perforated panel see page 171.

**Shelving cabinet 100/50/200 with accessories**

Size W x D x H mm	Max load kg	Code blue doors	Code ESD grey doors
1030 x 530 x 2010	600	SC10050213-07	SC10050213-49

Includes 4 shelves and 4 drawers. For additional drawers, shelves and perforated panel see page 171.



**Shelving cabinet 100/40/200 with accessories**

Size W x D x H mm	Max load kg	Code blue doors	Code ESD grey doors
1030 x 430 x 2010	600	SC10040211-07	SC10040211-49

Includes 3 shelves, 2 drawers and 1 perforated panel. For additional drawers, shelves and perforated panel see page 171.

**Shelving cabinet 100/40/200 with max load 1000 kg**

Size W x D x H mm	Max load kg	Code blue doors	Code ESD grey doors
1030 x 430 x 2010	1000	C 344 07 001	C 344 49 001

Includes 4 shelves. Delivered unassembled.



**Shelving cabinet 100/40/200 with max load 1000 kg**

Size W x D x H mm	Max load kg	Code blue doors	Code ESD grey doors
1030 x 430 x 2010	1000	C 344 07 004	C 344 49 004

Includes 2 shelves, 2 perforated panels and 3 drawers. Delivered unassembled.

**Perforated panels for shelving cabinets**

Name	Size W x H mm	Code
Perforated panel 1000	983 x 500	852 145-07/49
Perforated panel for the door	388 x 712	726 108-07/49

**Shelves for shelving cabinets**

Name	Size W x D mm	Max load kg	Code
Shelf	1000 x 400	150	852 231-49
Shelf	1000 x 500	150	852 185-49
Shelf	1000 x 600	150	852 187-49
Additional support for shelf 1000			852 267-49
Slanted shelf*	1000 x 400	100	852 247-49
Slanted shelf *	1000 x 500	100	852 248-49
Brackets included.			
*Slanted 17° (400 mm deep), 13° (500 mm deep).			

**Shelf dividers for shelving cabinets**

Name	Size D x H mm	Code
Steel divider pair	285 x 190	861 116-49
Steel divider pair	385 x 190	861 118-49

**Drawers and interior combinations for shelving cabinets**

Name	Size W x D x H mm	Max load kg	Code
Drawer 100/100, for 400 deep cabinet	920 x 345 x 107	30	834 513-49
Drawer 100/100, for 500 deep cabinet	920 x 345 x 107	30	834 514-49
1 Middle divider and middle plates			834 507-49
2 Middle divider and middle plates			834 508-49
3 Middle divider and middle plates			834 509-49
4 Pick up boxes			834 512-00

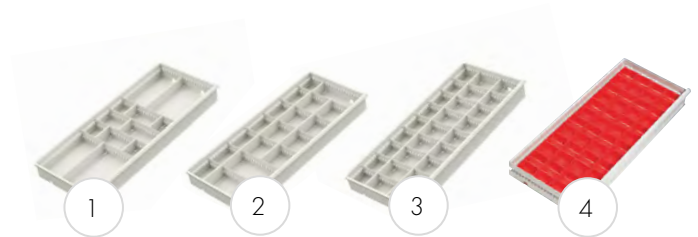

Some shelving cabinets are also available in black. Explore the range on our website.

# Industrial cabinets



1000 kg  
100 kg/shelf

Sturdy, quality storage cabinets made from powder-coated steel provide storage suitable for industrial and technical environments. The cabinet frames have a lock with two keys, sturdy double leaf-doors and adjustable feet, and with a wide range of accessories it can be easily customized into versatile storage solutions, e.g. for tool storage or shelving. The industrial cabinets are pre-assembled.

The industrial cabinets are made of epoxy powder coated steel. The frames are painted with light grey RAL 7035 and doors either with blue RAL5007 or with light grey RAL7035.

All cabinets are also available with flush fitting handle lock or digital code lock.

Alternate locking method can be ordered by adding a T or E in the end of the product code (e.g. C309 07 000 T).



**T** = for flush fitting handle



**E** = for digital code lock

Both locks are also available to the shelving system cabinets.

## Industrial cabinet 55/100 with 2 shelves

Size W x D x H mm	Max load kg	Code blue doors	Code ESD grey doors
550 x 425 x 1000	1000*	C 301 07 001	C 301 49 001
* 100 kg / shelf			
Flush fitting handle not suitable.			

## Industrial cabinet 55/160 with 3 shelves

Size W x D x H mm	Max load kg	Code blue doors	Code ESD grey doors
550 x 425 x 1600	1000*	C 303 07 001	C 303 49 001
* 100 kg / shelf			
Flush fitting handle not suitable.			



100 cm high cabinet tops have a back stop and rubber mat to be used as an additional work top.

## Industrial cabinet 80/160 with 3 shelves

Size W x D x H mm	Max load kg	Code blue doors	Code ESD grey doors
800 x 425 x 1600	1000*	C 307 07 001	C 307 49 001
* 100 kg / shelf			

## Industrial cabinet 80/200 with accessories

Size W x D x H mm	Max load kg	Code blue doors	Code ESD grey doors
800 x 425 x 2000	1000*	C 309 07 102T	C 309 49 102T
* 100 kg / shelf			
Includes 3 shelves, 2 drawers, 2 perforated panels for the door, 1 perforated panel for the back wall, pair of support feet			



## ESD versions available!

All industrial cabinets can be ordered as ESD versions by replacing the colour code 07 (blue) with 49 (ESD light grey). This means that in addition to the cabinet frame, the doors will also be painted with light grey ESD paint, RAL 7035. Please remember to use only ESD bins and mats with these ESD industrial cabinets.



### Industrial cabinet 80/100 with 2 shelves

Size W x D x H mm	Max load kg	Code blue doors	Code ESD grey doors
800 x 425 x 1000	1000*	C 305 07 001	C 305 49 001
*100 kg / shelf			



### Industrial cabinet 80/200 with 4 shelves

Size W x D x H mm	Max load kg	Code blue doors	Code ESD grey doors
800 x 425 x 2000	1000*	C 309 07 001	C 309 49 001
*100 kg / shelf			



#### Move with a pallet truck

The cabinet can be moved with a pallet truck or a forklift when the plinth front panel has been removed. Cabinets are equipped with leveling screws.

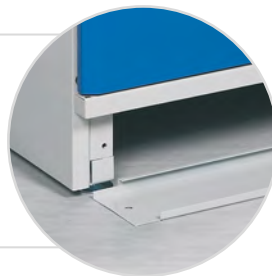

### Industrial cabinet 80/200 with plexiglass doors and 4 shelves

Size W x D x H mm	Max load kg	Code blue doors	Code grey doors
800 x 425 x 2000	1000*	C 309 07 001-TD	C 309 41 001-TD
*100 kg / shelf.			

Not available as ESD-protected.



**Industrial cabinet frames**

Name	Size W x D x H mm	Max load kg	Code blue doors	Code grey doors
Cabinet frame 55/100	550 x 425 x 1000	1000	C 301 07 000	C 301 49 000
Cabinet frame 80/100	800 x 425 x 1000	1000	C 305 07 000	C 305 49 000
Cabinet frame 55/160	550 x 425 x 1600	1000	C 303 07 000	C 303 49 000
Cabinet frame 80/160	800 x 425 x 1600	1000	C 307 07 000	C 307 49 000
Cabinet frame 80/160, half doors	800 x 425 x 1600	1000	C 307 07 004	C 307 49 004
Cabinet frame 80/200	800 x 425 x 2000	1000	C 309 07 000	C 309 49 000
Cabinet frame 80/200, plexiglass doors	800 x 425 x 2000	1000	C 309 07 000-TD	C 309 41 000-TD

Cabinet frames can be ordered with a turning handle with integrated key lock by adding a T in the end of the product code (e.g. C 309 07 000 T). Not suitable for 55/100 and 55/160.

Most of the M750 accessories fit the cabinet 80 and can be easily installed inside.

**Industrial cabinet accessories**

Name	Size W x D x H mm	Max load kg	Code
Perforated panel for the door or side wall	290 x 740		854 353-07/-49
Perforated panel for the back wall M500	468 x 389		860 951-49
Perforated panel for the back wall M750	736 x 640		835 633-07/-49
Perforated panel for the back wall M750	736 x 1003		835 641-07/-49
Pair of steel dividers	1 x 285 x 190		861 116-49
Steel shelf 55	545 x 391 x 32	100	854 349-49
Steel shelf 80	730 x 396 x 32	100	854 345-49
Extendable shelf 80	730 x 362 x 42	30	854 347-49
Drawer 55	480 x 362 x 90	30	854 344-49
Drawer 80	730 x 362 x 90	30	854 346-49
Drawer for suspension folders	724 x 350 x 240	30	854 348-49
Pair of support feet	40 x 220 x 6		864 730-49
Bin rail		50	859 151-41

**Cone rack M750**

Name	Size W x D mm	Max load kg	Code
Cone rack M750	742 x 206 x 95	50	890 729-49

Can be mounted to uprights, Fitter's trolley, Basic trolley, industrial screen, Treston Tower and industrial cabinet.

**Tool holders**

Name	Cone rack M750 can hold pcs	Width mm	Code
Tool holder, HSK A40-B53	11	64	854 213-00
Tool holder, HSK A63-B83	8	82	854 212-00
Tool holder, HSK A100-B128	6	106	854 211-00
Tool holder, CAPTO C4	8	82	854 210-00
Tool holder, CAPTO C5	8	82	854 209-00
Tool holder, CAPTO C6	8	82	854 208-00
Tool holder, CAPTO C8	6	106	854 207-00
Tool holder, ISO 30	11	65	854 205-00
Tool holder, ISO 40	11	65	854 204-00
Tool holder, ISO 45	8	83	854 206-00
Tool holder, ISO 50	7	101	854 200-00



**Cone rack M750**

# Personal safety and computer cabinets

## Personal safety equipment cabinet 100/200

Size W x D x H mm	Max load kg	Code blue doors	Code grey doors
1030 x 630 x 2010	600	SC10060220-07	SC10060220-49

Cabinet for storing personal protective equipment in production facilities. Cabinet is over pressurized with filtered fan. Overpressure inside the cabinet keeps the dust away from cabinet. Cabinet does not have fire resistance classification.

## Personal safety equipment cabinet M750

Size W x D x H mm	Max load kg	Code blue doors
720 x 330 x 900	60	860 987-07

Personal safety equipment cabinet for storing personal protective equipment in production facilities. Cabinet is over pressurized with filtered fan. For wall mounting. Cabinet does not have fire resistance classification.

## Filter mat replacement set

Name	Code
Filter mat replacement set (5 pcs)	900 553-00

Replacement filters for personal safety equipment cabinets.

## Computer cabinet

Name	Size mm	Code
Computer cabinet	800 x 500 x 1600	854 358-49
Computer cabinet (without the energy rail)	800 x 500 x 1600	854 364-49

Computer cabinet protects equipment from dust and dirt, even in the most demanding conditions. The computer cabinet is pressurized and equipped with an air filter that keeps the dust out. A screen up to a maximum size of 26" will fit in the computer cabinet. Flush fitting handle not suitable.



# Shelving system



1000 kg  
150 kg/shelf

A versatile shelving system that meets nearly all storage needs. Can be assembled to meet individual needs by combining shelves and shelving system cabinets, and by adding accessories as needed. The cabinets and shelving can also be used individually. Includes a wide range of accessories and add-ons for creating customized storage solutions.

The storage system is available in two standard heights: 200 cm and 240 cm and two widths: 80 cm and 100 cm.

## 1. Shelving system, standard bays

Name	Size W x D x H mm	Code ESD
Standard bay 80/30/200	824 x 300 x 2000	C 313 49 001P
Standard bay 80/40/200	824 x 400 x 2000	C 314 49 001P
Standard bay 100/30/200	1024 x 300 x 2000	C 313 49 002P
Standard bay 100/40/200	1024 x 400 x 2000	C 314 49 003P
Standard bay 100/50/200	1024 x 500 x 2000	C 315 49 001P
Standard bay 100/60/200	1024 x 600 x 2000	C 316 49 001P
Standard bay 80/40/240	824 x 400 x 2400	C 314 49 002P
Standard bay 100/40/240	1024 x 400 x 2400	C 314 49 004P
Standard bay 100/50/240	1024 x 500 x 2400	C 315 49 002P
Standard bay 100/60/240	1024 x 600 x 2400	C 316 49 002P

All standard and extension bays include 6 shelves. For additional shelves see page 177.



## 2. Shelving system, extension bays

Name	Size W x D x H mm	Code ESD
Extension bay 80/30/200	804 x 300 x 2000	C 323 49 001P
Extension bay 80/40/200	804 x 400 x 2000	C 324 49 001P
Extension bay 100/30/200	1004 x 300 x 2000	C 323 49 002P
Extension bay 100/40/200	1004 x 400 x 2000	C 324 49 003P
Extension bay 100/50/200	1004 x 500 x 2000	C 325 49 001P
Extension bay 100/60/200	1004 x 600 x 2000	C 326 49 001P
Extension bay 80/40/240	804 x 400 x 2400	C 324 49 002P
Extension bay 100/40/240	1004 x 400 x 2400	C 324 49 004P
Extension bay 100/50/240	1004 x 500 x 2400	C 325 49 002P
Extension bay 100/60/240	1004 x 600 x 2400	C 326 49 002P

All standard and extension bays include 6 shelves. For additional shelves see page 177.



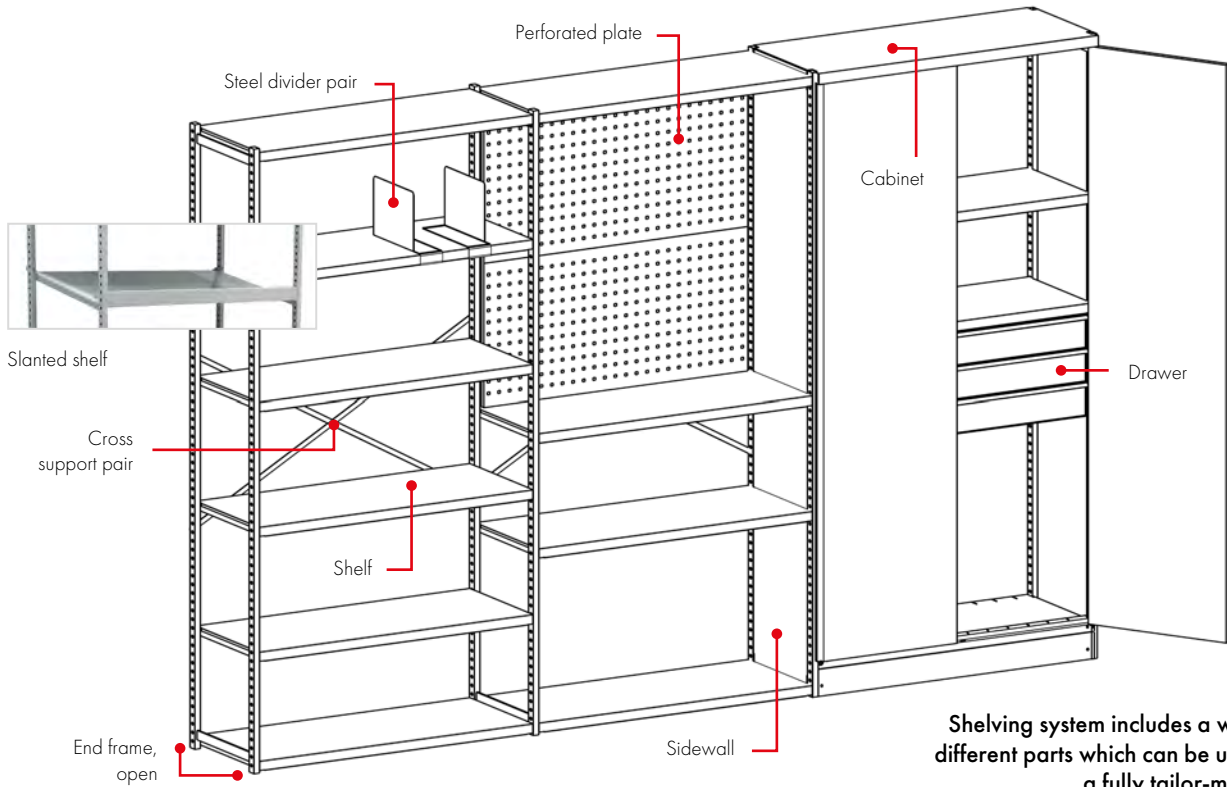

Shelving system includes a wide range of different parts which can be used to create a fully tailor-made solution.

**Shelving system components**

Name	Size D x H mm	Code
End frame, open	300 x 2000	830 615-49
End frame, open	400 x 2000	830 895-49
End frame, open	500 x 2000	851 719-49
End frame, open	600 x 2000	851 725-49
End frame, open	400 x 2400	851 717-49
End frame, open	500 x 2400	851 721-49
End frame, open	600 x 2400	851 724-49
Sidewall	400 x 2000	859 440-49
Sidewall	500 x 2000	859 450-49
Sidewall	600 x 2000	859 460-49
Cross support pair 1000		852 176-49
Cabinet 100/40/200	1030 x 430 x 2010	C 344 07 000
Cabinet 100/50/200	1030 x 530 x 2010	C 345 07 000
Cabinet 100/60/200	1030 x 630 x 2010	C 346 07 000
Back wall 1000	1000 x 2000	859 447-49
Perforated end plate 400*	340 x 2000	830 917-07
Screw set (fixing back to back)		838 440-51
Perforated panel 1000	983 x 500	852 145-07
Perforated panel for the door	388 x 712	726108-07/49

\* suitable for End frame open 400 x 2000.

Cabinets supplied in parts.

**Shelves**

Name	Size W x D mm	Max load kg	Code
Shelf	800 x 300	150	852 235-49
Shelf	800 x 400	150	852 234-49
Shelf	1000 x 300	150	852 175-49
Shelf	1000 x 400	150	852 231-49
Shelf	1000 x 500	150	852 185-49
Shelf	1000 x 600	150	852 187-49
Additional support for shelf 1000			852 267-49

Brackets included.

**Slanted shelves**

Name	Size W x D mm	Max load kg	Code
Slanted shelf	1000 x 400	100	852 247-49
Slanted shelf	1000 x 500	100	852 248-49

Brackets included. Slanted 17° (400 mm deep), 13° (500 mm deep).

**Shelf dividers**

Name	Size D x H mm	Code
Steel divider pair	285 x 190	861 116-49
Steel divider pair	385 x 190	861 118-49

**Drawers and interior combinations**

Name	Size W x D x H mm	Max load kg	Code
Drawer 100/100, for 400 deep cabinet	920 x 345 x 107	30	834 513-49
Drawer 100/100, for 500 deep cabinet	920 x 345 x 107	30	834 514-49
1 Middle divider and middle plates			834 507-49
2 Middle divider and middle plates			834 508-49
3 Middle divider and middle plates			834 509-49
4 Pick up boxes			834 512-00

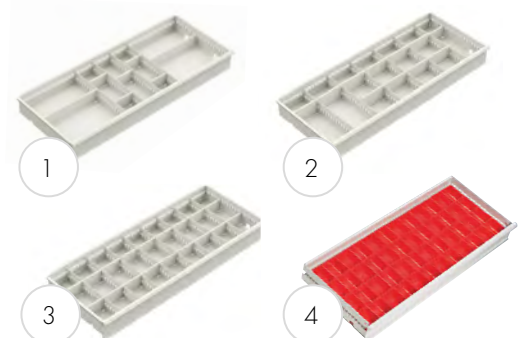

**Shelving system combination 100/30/200-8**

Size W x D x H mm	Max load kg	Code
2060 x 330 x 2000	1000 /bay	C 340 07 108

Includes 3 end frame/open, 8 shelves, 4 perforated panels and 2 cross support pairs.



**Shelving system combination 100/40/200-9**

Size W x D x H mm	Max load kg	Code
3090 x 430 x 2010	1000 / bay	C 340 07 109

Includes 1 cabinet, 2 end frame/open, 14 shelves, 2 perforated panels and 2 cross support pairs.



**Combination name**

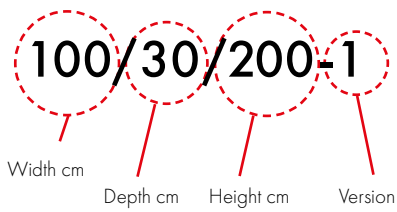

# Heavy shelving system



2000 kg  
350/400 kg/shelf

A shelving system that stands firm under the toughest of conditions. Especially suitable for storing large and heavy objects and items. A shelving unit can be built from cabinets, drawers, and shelves, and it can have either open or solid sides.

The shelf load capacity is 400 kg (shelf width 700 mm) or 350 kg (shelf width 900 mm) kg, maximum load per bay is 2000 kg. The heavy storage system comes in one standard height of 200 cm and two widths: 75 cm and 95 cm.

## 1. Heavy shelving system, standard bays

Name	Size W x D x H mm	Code
Standard bay, open	750 x 714 x 2000	C 375 49 001
Standard bay, closed*	750 x 714 x 2000	C 376 49 001
Standard bay, open	950 x 714 x 2000	C 395 49 001
Standard bay, closed*	950 x 714 x 2000	C 396 49 001

All standard and extension bays include 6 shelves. For additional shelves see page 180.

\*The standard bay, closed, includes back sheet and closed ends.

## 2. Heavy shelving system, extension bays

Name	Size W x D x H mm	Code
Extension bay, open	705 x 714 x 2000	C 377 49 001
Extension bay, closed*	705 x 714 x 2000	C 378 49 001
Extension bay, open	905 x 714 x 2000	C 397 49 001
Extension bay, closed*	905 x 714 x 2000	C 398 49 001

All standard and extension bays include 6 shelves. For additional shelves see page 180.

\*The extension bay, closed, includes back sheet and closed end.



### The W x D x H rule

All our dimensions follow a WDH rule, where the first dimension is the width (W), the middle the depth (D), and the last the height (H).

Heavy shelving system includes a wide range of different parts which can be used to create a fully tailor-made solution.

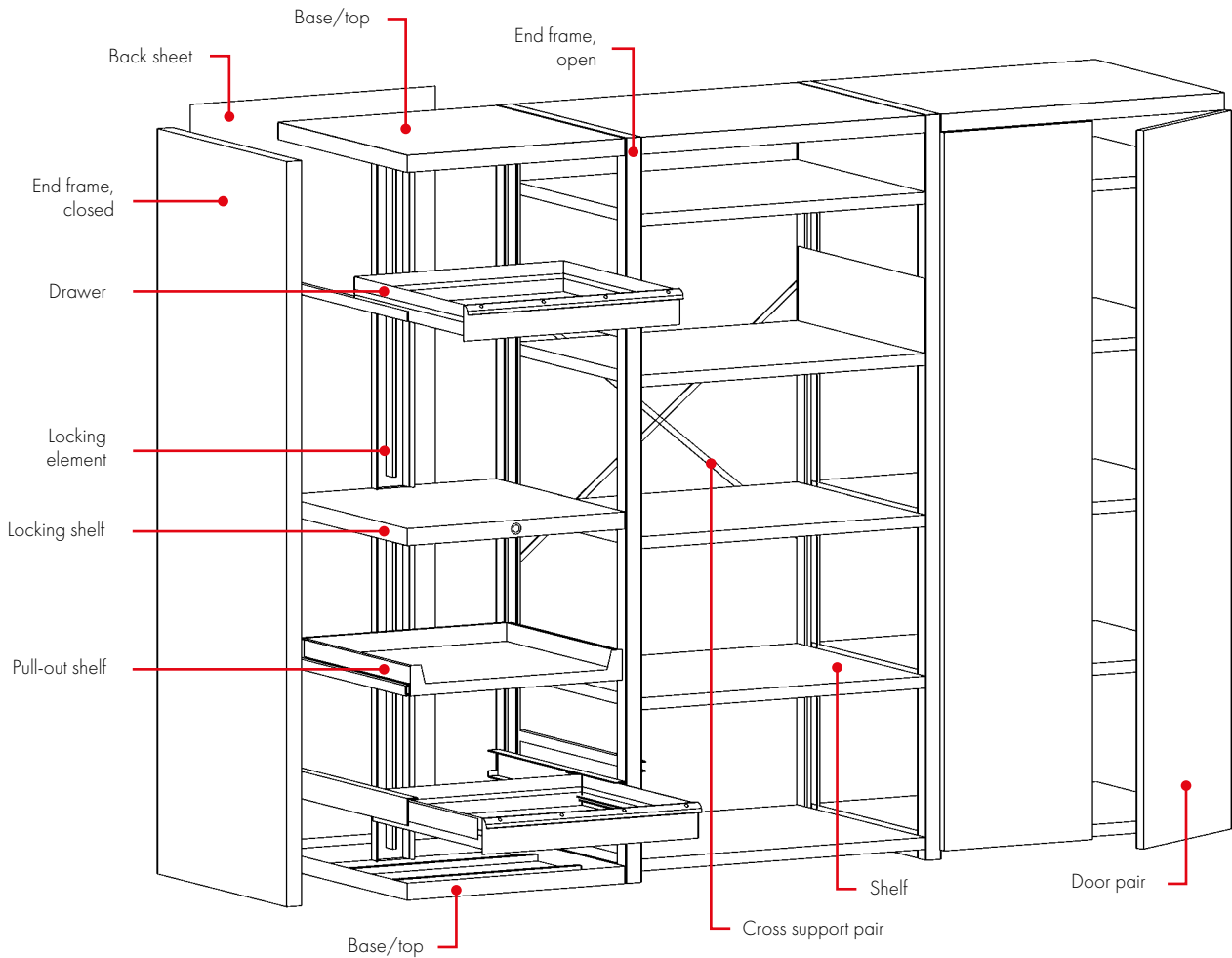

**Heavy shelving system components**

Name	Size W x D mm	Code
End frame/open	714 x 2000	852 002-49
End frame/closed	714 x 2000	852 001-49
Base/top 70	660 x 714	852 004-49
Base/top 90	860 x 714	852 013-49
Cross support pair		851 671-49
Back sheet 70	740 x 1990	852 009-49
Back sheet 90	940 x 1990	852 016-49
Door pair*	700 x 2000	852 000-07/49
Door pair*	900 x 2000	852 011-07/49

\*Door equipped with lock.

**Heavy shelving system shelves**

Name	Size W x D mm	Max load kg	Code
Shelf 70	660 x 714	400	852 003-49
Shelf 90	860 x 714	350	852 012-49
Locking shelf 70	660 x 714	400	852 007-49
Locking shelf 90	860 x 714	350	852 015-49
Locking element	1000		851 675-49
Pull-out shelf 70*	612 x 612 x 85	200	852 017-07H/41H
Pull-out shelf 90*	860 x 612 x 85	200	852 019-07H/41H

Brackets included. Locking shelf equipped with lock.

\* The pull-out shelves are not ESD protected.

**Heavy shelving system drawers**

Name	Size W x D mm	Effective height mm	Max load kg	Opens %	Code
Drawer 70/75	612 x 612 x 75	49	200	100	833 401-07H
Drawer 70/100	612 x 612 x 100	74	200	100	833 975-07H
Drawer 70/150	612 x 612 x 150	124	200	100	833 983-07H
Drawer 70/250	612 x 612 x 250	224	200	100	833 991-07H
Drawer 90/75	860 x 612 x 75	49	200	100	854 262-07H
Drawer 90/100	860 x 612 x 100	74	200	100	854 246-07H
Drawer 90/150	860 x 612 x 150	124	200	100	854 248-07H
Drawer 90/250	860 x 612 x 250	224	200	100	854 249-07H

Drawers are also available in grey, colour code -41. The drawers are not ESD protected.

**Heavy shelving system example 1**

Qty	Name	Size mm	Code
2	Base/top 90	860 x 714	852 013-49
1	Back sheet 90	940 x 1990	852 016-49
2	End frame/closed	714 x 2000	852 001-49
5	Shelf 90	860 x 714	852 012-49
1	Door pair	900 x 2000	852 011-07

**Heavy shelving system example 2**

Qty	Name	Size mm	Code
2	Base/top 90	860 x 714	852 013-49
1	Back sheet 90	940 x 1990	852 016-49
2	End frame/closed	714 x 2000	852 001-49
2	Shelf 90	860 x 714	852 012-49
1	Locking shelf 90	860 x 714	852 015-49
1	Locking element 1000		851 675-49
3	Pull-out shelf 90	860 x 612	852 019-07H
1	Door pair	900 x 2000	852 011-07

**Heavy shelving system example 3**

Qty	Name	Size mm	Code
4	Base/top 90	860 x 714	852 013-49
2	Back sheet 90	940 x 1990	852 016-49
3	End frame/closed	714 x 2000	852 001-49
8	Shelf 90	860 x 714	852 012-49
2	Pull-out shelf 90	860 x 612	852 019-07H

**Heavy shelving system example 4**

Qty	Name	Size mm	Code
1	Standard bay, open	950 x 714 x 2000	C 395 49 001
2	Extension bay, open	905 x 714 x 2000	C 397 49 001



# Perforated panels



Perforated panels are efficient dividers of space and, at the same time, practical storage facilities for tools and equipment. An industrial screen can be used as a sound-insulating space divider by equipping it with back panel elements with fireproof insulation.

## Order and tidiness are appreciated

Order and tidiness cannot be achieved and maintained without there being a place for each tool. Perforated panels and hooks offer a practical and versatile solution for storing tools and equipment. Perforated panel products are available for direct fastening to the wall or for fastening to upright profiles or tubes.

# Perforated back and wall panels

The perforated back panels are fastened either to the upright tubes (with Concept, Treston QuatreX, TED, TP benches and Heavy duty benches) or accessory frame AKK (with WB and Treston QuatreX bench). The size of the perforation is 9 x 9 mm, center to center 38 mm.

## 1. Perforated panels for upright tubes

Name	Module	Size W x H mm	Code
Perforated back panel	M500	468 x 389	861 501-07/-49
Perforated back panel	M750	718 x 194	861 510-07/-49
Perforated back panel	M750	718 x 389	861 511-07/-49
Perforated back panel	M750	718 x 612	861 512-07/-49/-18
Perforated back panel, insulated	M750	718 x 612	861 701-07/-49
Perforated back panel	M750	718 x 1003	861 514-07/-49/-18
Perforated back panel	M900	871 x 389	861 516-07/-49
Perforated back panel	M900	871 x 612	861 517-07/-49
Perforated back panel	M900	871 x 1003	861 519-07/-49
Perforated back panel	M1000	968 x 389	861 532-07/-49
Perforated back panel	M1000	968 x 612	861 538-07/-49
Perforated back panel	M1000	968 x 1003	861 535-07/-49
Perforated back panel	M1200	1168 x 389	861 533-07/-49
Perforated back panel	M1350	1318 x 389	861 521-07/-49
Perforated back panel	M1500	1474 x 389	861 526-07/-49
Perforated back panel	M1800	1774 x 389	861 531-07/-49

Fastened to the upright tubes (see page 69).

Codes: -07 = blue, -49 = grey, -18 = black

## 2. Back panels for upright tubes

Name	Module	Size W x H mm	Code
Back panel	M500	468 x 389	861 541-49
Back panel	M750	718 x 194	861 550-49
Back panel	M750	718 x 389	861 551-49
Back panel	M750	718 x 612	861 552-49
Back panel	M900	871 x 389	861 556-49

Fastened to the upright tubes (see page 69).

## 3. Perforated wall panels fastened to the wall

Name	Size W x H mm	Code
Perforated wall panel	454 x 988	837 369-07
Perforated wall panel	949 x 988	837 334-07/-18
Perforated wall panel	949 x 1444	837 342-07
Perforated wall panel	949 x 1976	837 350-07/-18

Fastened directly to the wall using screws.

Codes: -07 = blue, -18 = black

## 4. Perforated panels for TPH benches

Size W x H mm	Suitable for	Code
1115 x 750	TPH712	RL120
1415 x 750	TPH715/915	RL150
1715 x 750	TPH718/918	RL180
Panel hooks	TPH	RK1

Mount on TPH benches with panel hooks RK1. Can also be attached to a wall with screws (included).



## 5. Perforated panels for WB and Treston QuatreX benches

Size W x H mm	Suitable for	Code
668 x 500	AKK70, AKK150	ARL70
968 x 500	AKK180	ARL100

Mount on accessory frame AKK (see page 85).

# Perforated industrial screens

These industrial screens are modular, and they can be equipped with all M750 accessories. Industrial screens can be used as space dividers. They can also provide noise insulation; the combinations available have perforated back panels on both sides and one side is insulated.

## Industrial screens

Name	Size W x D x H mm	Max load kg	Code
Standard part, T-feet	780 x 560 x 1850	300	C 520 07 101
Extension part, T-foot	750 x 560 x 1850	300	C 520 07 102
Extension part, L-foot	750 x 310 x 1850	300	C 520 07 103
Extension part, I-foot	750 x 60 x 1850	300	C 520 07 104

Includes 6 perforated back panels, 3 pcs/side.

The standard part includes two feet.

The extension part includes one foot.

## Parts

Name	Size W x D x H mm	Code
T-foot	1850	836 516-49
L-foot	1850	836 532-49
I-foot	1850	836 597-49
Spacer bar	750	835 838-49
Corner joint pair*		847 615-51
Perforated back panel M750	718 x 17 x 612	861 512-07/-49
Perforated back panel M750, insulated**	718 x 17 x 612	861 701-07/-49
Upper list	718 x 65	851 907-07

The wall module requires two spacer bars.

\* For fixing two wall modules at 90° angle

\*\* The insulation material used is polyether foam.

Most M750 accessories are suitable for the industrial screen.

## Examples of industrial screen accessories

Name	Size W x D mm	Max load kg	Code
Steel shelf M750	740 x 300	50	836 028-49
Steel shelf M750	740 x 400	50	852 770-49
Bin rail M750	742 x 100	50	859 151-41
Auxiliary steel shelf for perforated panel	159 x 243 x 56		ASSA5PP



Standard part, T-feet



Extension part, T-foot



Extension part, L-foot

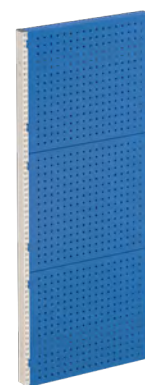

Extension part, I-foot



Steel shelf



Bin rail M750 with brackets and stacking bins.



Auxiliary steel shelf for perforated panel



**More accessories starting from page 69.**

M750 accessories suit these industrial screens.



**The colour code is included in those product codes that are formed with numbers.**

It is either at the end, following the hyphen (e.g. 860 804-49), or in the middle (e.g. C:334 07 000).

# FiFo Flow Rack



**Treston FiFo Flow Rack is a flexible shelving, storage and picking solution.** It brings the items from the warehouse nearby the production, assembly or packing station. Ensures the needed parts are at hand and no time is wasted searching for items, supporting LEAN operations. FiFo (First in First out) flow ensures the oldest components are available first and the inventory is at a good level. Reduce errors and allow personnel to concentrate on the work at hand improving quality.



No tools needed to easily modify for different size bins and items.



Quick and easy to assemble and adjust. Only an Allen key is needed for assembly, and a wrench for levelling the feet.



Easy to accessorize, wide selection of accessories. Can be turned into a workstation with an additional shelf.



**FiFo Flow Rack**

Name	Suitability of bins	Module	Size W x D x H mm	Max load kg	Code ESD
1 FiFo Flow Rack	24 pcs Treston stacking bins 1940 or similar.	M900	933 x 805 x 1860	700	TFR900-49
	24 pcs Treston stacking bins 3040, 24 pcs 300 x 400 euroboxes or similar.	M1350	1385 x 805 x 1860	700	TFR1350-49
2 FiFo Flow Rack, rear extension	24 pcs Treston stacking bins 1940 or similar.	M900	933 x 735 x 1860	700	TFR900RE-49
	24 pcs Treston stacking bins 3040, 12 pcs 300 x 400 euroboxes or similar.	M1350	1385 x 735 x 1860	700	TFR1350RE-49
3 FiFo Flow Rack, side extension	24 pcs Treston stacking bins 1940 or similar	M900	933 x 805 x 1860	700	TFR900SE-49
	24 pcs Treston stacking bins 3040, 24 pcs 300 x 400 euroboxes or similar.	M1350	1385 x 805 x 1860	700	TFR1350SE-49
4 FiFo Flow Rack, side-rear extension	24 pcs Treston stacking bins 1940 or similar.	M900	933 x 735 x 1860	700	TFR900SRE-49
	24 pcs Treston stacking bins 3040, 12 pcs 300 x 400 euroboxes or similar.	M1350	1385 x 735 x 1860	700	TFR1350SRE-49

Rack includes 3 roller tops which are adjustable without any tools. Each roller top includes 8 pcs roller profiles and 3 pcs guide plates.

**Many other bin size options are suitable by adding or removing roller profiles and guide plates.**

**FiFo Flow Rack with steel shelves**

Name	Suitability of bins	Module	Size W x D x H mm	Max load kg	Code ESD
FiFo Flow Rack, steel shelves	24 pcs Treston stacking bins 1940 or similar.	M900	933 x 805 x 1860	700	TFR900SS-49
	32 pcs Treston stacking bins 3040, 300 x 400 euroboxes or similar. Alternatively 48 pcs Treston stacking bins 1940 or similar.	M1350	1385 x 805 x 1860	700	TFR1350SS-49

The rack includes 4 steel shelves which are adjustable.



**Extendable with rear and side modules – with as many modules as needed.**



**FiFo Flow Rack accessories**

Name	Description	Module	Size W x D x H mm	Max load kg	Code ESD
1 Roller top	An extra roller top increases the space for the bins in the FiFo flow rack. Includes fixing brackets.	M900 M1350	852 x 766 x 105 1279 x 766 x 105	220 220	TFRRT900-49 TFRRT1350-49
2 Roller top, rear extension	An extra roller top of rear extension increases the space for the bins in rear extension FiFo flow rack. Includes fixing brackets.	M900 M1350	852 x 766 x 105 1279 x 766 x 105	220 220	TFRRT900RE-49 TFRRT1350RE-49
3 Additional shelf for FiFo Flow Rack with steel shelves	An extra steel shelf increases the space for the bins in steel shelves version of FiFo flow rack. Includes fixing brackets.	M900 M1350	852 x 789 x 53 1310 x 789 x 52	220 220	TFRAS900-49 TFRAS1350-49
4 Roller profile set, 4 pcs Guide plate set, 3 pcs	Extra roller profiles and guide plates allow you to increase storage space by using smaller bins in your FiFo flow rack.		29 x 734 x 37 2 x 718 x 70		TFRRS-49 TFRGP-49
5 Perforated panel set, 2 pcs (left, right)	With perforated panels you can cover both side of FiFo flow rack. With the panel hooks you can use the side panels easily as tool storage as well.		15 x 736 x 812		TFRPP-49
6 Castor set ESD*	Castor set for Treston FiFo Flow Rack M900 ESD Castor set for Treston FiFo Flow Rack M1350 ESD			300 300	TFR900CS-49 TFR1350CS-49

\* Also non-ESD castors available, use code TFR900CS-41 / TFR1350CS-41.

All Treston accessories available for upright tubes are suitable for FiFo Flow Rack.



Watch the 2 min **animation** showcasing the features

# Tool storage systems

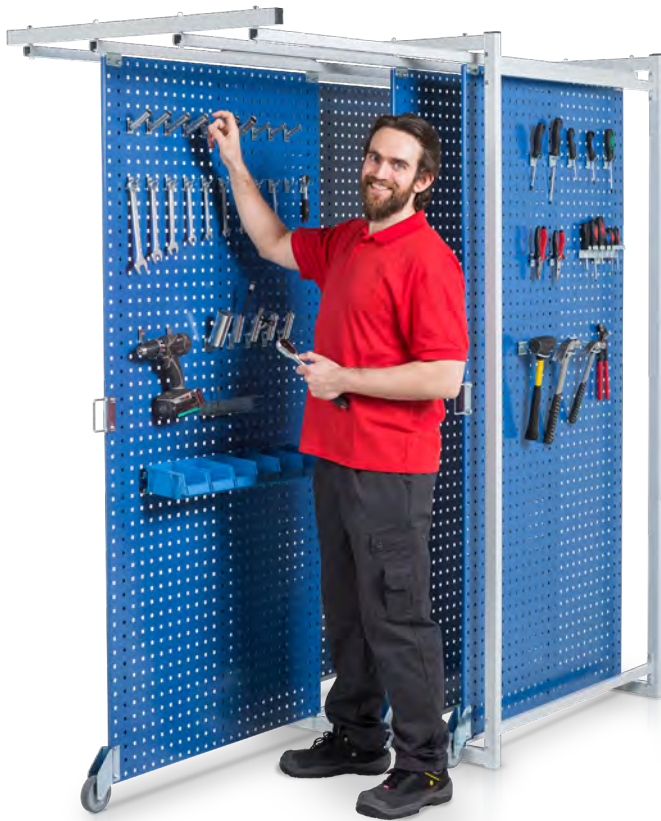

These two little giants, Treston tool storage system and Treston Tower, provide efficiency and order to the storage of tools and components. Their capacity is sufficient even for extremely heavy loads, and thanks to the versatile selection of accessories, you can customise them to meet your needs.

The tool storage system is a handy storage solution comprising a sturdy frame and perforated panels. Treston Tower is a 4-sided, movable little giant for efficient storage and work.

+

Treston Industrial Multi Trolley with perforated panels can also efficiently store your tools. See more on page 126.



# Tool storage system

**Tool storage system requires only 2 m<sup>2</sup> of floor space and provides 16 m<sup>2</sup> of storage space.** There is no need to fasten it to the floor, as it stands firmly on its own. There is a castor on the lower edge of the panels which makes them easy to move.

The load capacity is 100 kg/panel. Includes 4 panels; additional panels are available (ordered separately). A maximum of 10 panels can be fastened to the tool storage system.



## Tool storage system

Name	Size W x H mm	Code blue	Code grey	Code black
Tool storage system, 4 panels	1025 x 1035 x 2125	830 518-07P	830 518-49P	830 518-18
Additional panel	15 x 949 x 1976	830 682-07P	830 682-49P	830 682-18



Watch this [animation](#) showcasing the versatile usage options of our technical furniture

# Treston Tower storage and workstation unit

Being versatile and easily customisable for different environments and tasks, the Treston Tower storage and workstation unit is ideal for, for example, vehicle and machinery assembly lines, service and maintenance departments, and for any work that requires plenty of mobile storage and workspace near the product under work.

When the storage and/or load capacity of a wheeled service trolley or drawer unit is not enough and you need a unit that is easier to move than a fixed workstation and can be equipped in many ways, the Treston Tower storage and workstation unit is the correct choice.

The frame is made of powder-coated steel (grey, RAL7045). Accessories and add-on products are available in light grey (RAL7035).



## Treston Tower storage and workstation unit

Name	Size W x D x H mm	Max load kg	Code
Treston Tower frame	860 x 880 x 1960	1000	890 700-45
Treston Tower frame with castors	860 x 880 x 2105	600	890 701-45





**Examples of accessories and add-on products**

Name	Size W x D x H mm	Max load kg	Code
1 Flow-through shelf + brackets M750*	718 x 830	150	890 710-49
2 Spacer bar, M750**			851 483-49
3 Perforated back panel M750, max 3 pcs/side	718 x 612		861 512-49
4 Hook set 3 (69 pcs)			855 003-51
5 Steel shelf M750	740 x 400	50	852 770-49
6 Bin rail M750	742 x 100	50	859 151-41
7 LCD monitor holder for perforated panel		10	890 715-49
8 Treston NaturLite Led Wing 500	430 x 120 x 50 (+ bracket 95/120 mm)		TNL500W

\* A flow-through shelf can fit two 400-mm deep shelf bins successively.

\*\* Recommended to be used with flow-through shelving.



**Wide range of accessories and add-on products**

Because the frame is equipped with the M750 upright frame module, almost all modular size M750 accessories are compatible with the Treston Tower storage and workstation unit. Also remember the tool hooks (R hooks) and stacking and shelf bins.



Watch this [animation](#) showcasing the versatile usage options of our technical furniture

# Panel hooks



Our selection includes more than 50 different kinds of hooks and brackets for the efficient storage and organisation of tools. All the panel hooks and tool holders are easy to attach to the perforated panels and wall panels. The perforated panels are an efficient way to integrate the tool holders and panel hooks to Treston workbenches, trolleys and cabinets. You can also create a tool storage on the wall by using the perforated wall panels.

## Hooks also for heavy loads

The hooks can withstand loads of up to 10 kg.



# Panel hooks

## Hook R1

Name	L	Ø	Max load kg	Code
Hook R1	30	3	10	853 207-51
Hook R1	50	4	10	853 208-51
Hook R1	50	6	10	853 241-51
Hook R1	80	6	10	853 209-51
Hook R1	100	4	8	853 210-51
Hook R1	100	6	10	853 211-51
Hook R1	150	4	4	853 212-51
Hook R1	150	6	10	853 213-51
Hook R1	200	4	2	853 214-51
Hook R1	200	6	6	853 215-51
Hook R1	300	6	3	853 216-51
Hook R1	300	8	8	853 217-51

L = hook length mm

All order numbers include 5 pcs.

## Hook R2

Name	L	Ø	A	Max load kg	Code
Hook R2	33	3	17	10	853 218-51
Hook R2	43	4	25	10	853 219-51
Hook R2	43	4	40	10	853 220-51
Hook R2	100	6	25	10	853 221-51
Hook R2	150	4	16,5	6	853 222-51
Hook R2	150	6	25	10	853 223-51
Hook R2	200	6	25	10	853 224-51

L = hook length mm

A = free gap mm

All order numbers include 5 pcs.

## Hook R3

Name	L	Ø	Max load kg	Code
Hook R3	10	6	10	853 225-51
Hook R3	50	6	10	853 226-51

L = hook length mm

All order numbers include 5 pcs.

## Hook R10

Name	L	A	Max load kg	Code
Hook R10	28	9	10	853 227-51
Hook R10	33	17	10	853 228-51

L = hook length mm

A = free gap mm

All order numbers include 5 pcs.

## Hook R13

Name	L	Ø	Max load kg	Code
Hook R13	157	3	1	853 229-51

L = hook length mm

The order number includes 5 pcs.

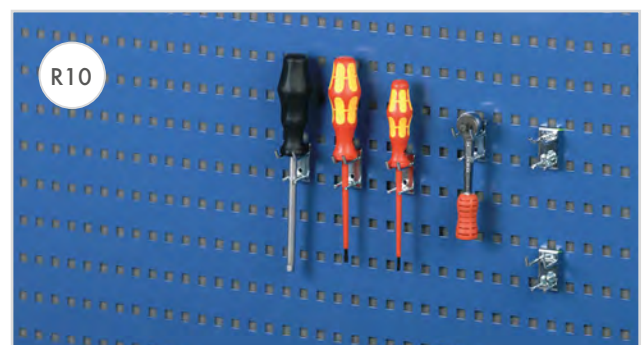

**Hook R16**

Name	L	Max load kg	Code
Hook R16	20	10	831 514-51
Hook R16	46	10	831 506-51

L = hook length mm

All order numbers include 1 pc.

**Hook R19**

Name	Ø	Code
Hook R19	13	853 231-51
Hook R19	19	853 232-51
Hook R19	22	853 233-51

All order numbers include 5 pc.

**Hook R24**

Name	L	Ø	Code
Hook R24	65	17	831 700-51
Hook R24	80	26	831 719-51
Hook R24	100	42	852 167-51

L = hook length mm

All order numbers include 1 pc.

**Hook R26**

Name	L	Ø	Code
Hook R26	160	10	838 896-51

L = hook length mm

The order number includes 1 pc.

**Hook R29**

Name	L	Max load kg	Code
Hook R29	40	5	853 234-51
Hook R29	60	5	853 235-51
Hook R29	80	10	853 236-51

L = hook length mm

All order numbers include 5 pcs.

**Hook R30**

Name	L	Ø	Max load kg	Code
Hook R30	35	4	10	853 237-51
Hook R30	85	6	10	853 238-51

L = hook length mm

All order numbers include 5 pcs.

**Hook R33**

Name	H	Ø	Code
Hook R33	30	90	832 162-51

H = hook height mm

The order number includes 1 pc.

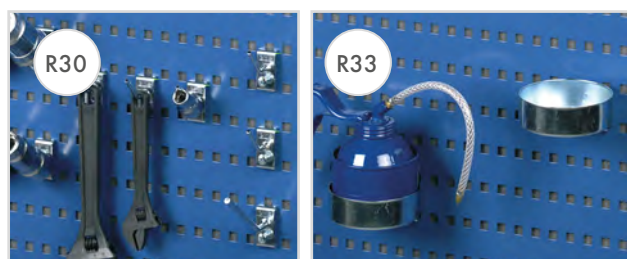
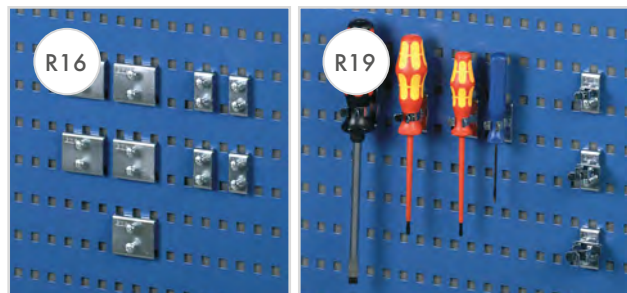

**Hook R35**

Name	L	A	Max load kg	Code
Hook R35	17	35	5	853 239-51
Hook R35	17	55	5	853 240-51

L = hook length mm

A = free gap mm

All order numbers include 5 pcs.

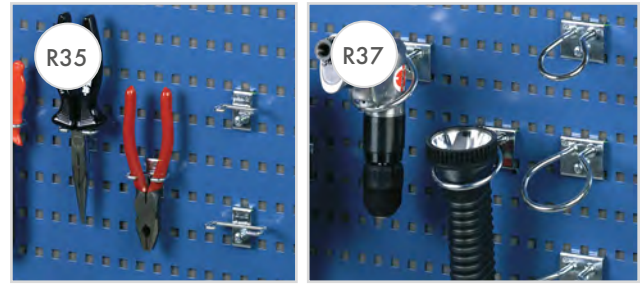
**Hook R37**

Name	Ø	Max load kg	Code
Hook R37	40	10	831 433-51
Hook R37	60	10	831 441-51
Hook R37	80	10	831 603-51

All order numbers include 1 pc.

**Hook R41**

Name	L	Code
Hook R41	556	838 357-51

L = hook length mm

The order number includes 1 pc.

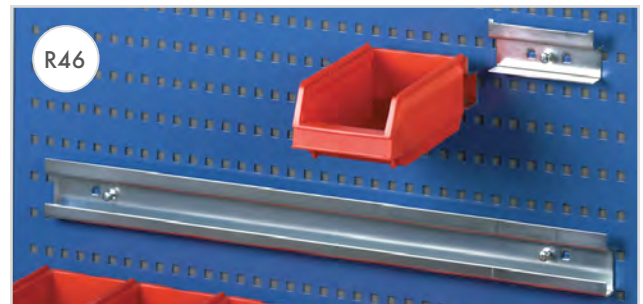
**Hook R46**

Name	L	Code
Hook R46	112	for stacking bins 1015 and 30-1L 831 794-51
Hook R46	634	bin rail for six stacking bins 1015 and 30-1L 839 086-51

L = hook length mm

All order numbers include 1 pc.

**Hook R47**

Name	W x D	Max load kg	Code
Hook R47	350 x 120	4	831 654-49

The order number includes 1 pc.

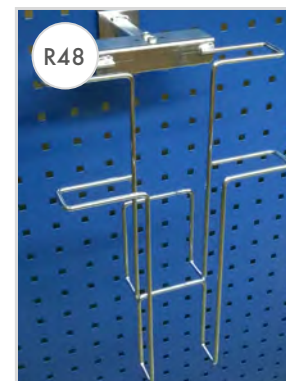
**Hook R48**

Name	W x D x H	Code
Hook R48	235 x 200 x 370	838 380-51

The order number includes 1 pc.

**Hook R49**

Name	W x D x H	Code
Hook R49	300 x 70 x 40	838 381-51

The order number includes 1 pc.



**Hook R50**

Name	W x D x H	Code
Drill bit holder	238 x 43x 60/80	838 382-51
The order number includes 1 pc.		

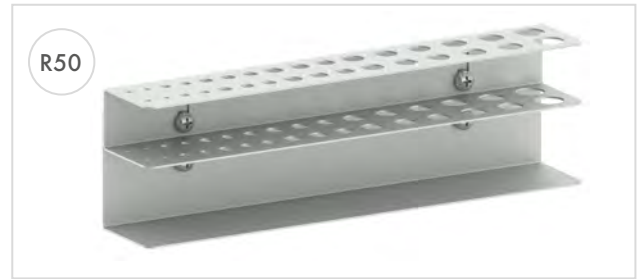

**Other supplies**

Name	Size W x D x H mm	Max load kg	Code
Paper roll holder	max roll width 300 mm		854 043-49
Box holder for four pick up boxes	456 x 165 x 48	5	854 042-49
Pick up box	149 x 85 x 48		851 843-00
Utility box	410 x 155 x 90	4	854 041-49
Folder compartment	466 x 90 x 240	4	854 040-49
LCD monitor holder for perforated panel	120 x 38 x 150	10	890 715-49
Auxiliary steel shelf for perforated panel	159 x 243 x 56		ASSA5PP
Bracket for fixing small plastic storage cabinet to perforated panel	274 x 12 x 46		890 535-51
Tape roll storage rack for perforated panel	122 x 110 x 254		TRRP-49
Waste bin, grey	320 x 220 x 270		839 159-ECO
Waste bin holder for perforated panel			854 044-49



**Paper roll holder**



**Box holder**

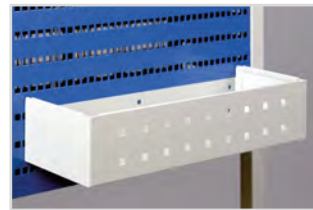

**Utility box**

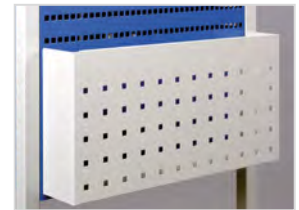

**Folder compartment**



**LCD monitor holder for perforated panel**



**Auxiliary steel shelf for perforated panel**



**Bracket for fixing small plastic storage cabinet to perforated panel**



**Tape roll storage rack for perforated panel**



**Waste bin**

# Hook sets

Ready-made hook sets help you to get started. Choose the most suitable hook set for your needs from the following possibilities:

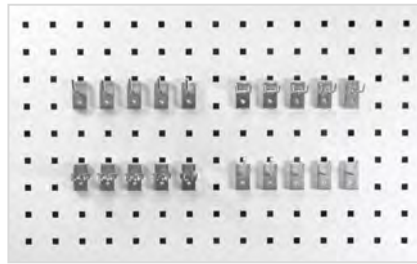

Hook set 1: Basic light hook set



Hook set 2: Basic hook set for hand tools



Hook set 3: Hook set for perforated tool cabinet



Hook set 4: All inclusive set for hand tools



Hook set 5: Hook set for heavy tools in perforated tool cabinet

Hooks included in the sets (Code)	Hooks sets							
	L mm	Ø mm	A mm	Set 1	Set 2	Set 3	Set 4	Set 5
R1 (853 207-51)	30	3		855 001-51	855 002-51	855 003-51	855 004-51	855 005-51
R1 (853 208-51)	50	4		5	5		10	10
R1 (853 211-51)	100	6						10
R2 (853 218-51)	33	3	17	5	5	5	5	5
R2 (853 219-51)	43	4	25				5	5
R2 (853 220-51)	43	4	40					5
R10 (853 227-51)	28		9					5
R10 (853 228-51)	33		17					5
R19 (853 231-51)		13					5	5
R19 (853 232-51)		19		5	5	5	5	5
R19 (853 233-51)		22			5			5
R24 (831 719-51)	80	26			1	5	7	3
R24 (852 167-51)	100	42				1	2	3
R29 (853 235-51)	60				5			5
R30 (853 237-51)	35	4		5	5	35	40	10
R33 (832 162-51)	30	90			1	1	2	1
R35 (853 239-51)	17		35		5		5	5
R35 (853 240-51)	17		55					5
R37 (831 441-51)		60			1		3	3
R49 (838 381-51)	300				2	1	1	2
R50 (838 382-51)	43		238			1		
Pieces				20	45	69	100	107

L = hook length mm  
A = free gap mm

# Bins and cabinets



**Storage bins and drawer storage units are the essence of small-parts storage and parts picking.** The wide selection of Treston products includes solutions for the sorting, storage, and use of items and parts of various shapes and sizes. Also suitable for EPAs. Durable and functional storage – now and in the future.

# Small-parts storage cabinets

These cabinets can be wall hung or mounted on bench top turntables, or stood on the work top. Two frames of different heights are available, 290 and 550 mm. A storage cabinet consists of a frame, shelves, small drawers and labels. The back of the cabinets feature ready-made holes for wall mounting. Cross and length dividers are available as an accessory.

+

Small drawers on page 214.



## Series 290 (Size W x D x H mm: 310 x 180 x 290)

Code	290-3	291-3	292-3	294-3	296-3	297-3	290C-3
Includes drawers of type (quantity/drawer)	L-00 (30 pcs)	L-01 (24 pcs)	L-02 (12 pcs)	L-04 (12 pcs)	L-06 (4 pcs)	L-07 (6 pcs)	L-01 (12 pcs) L-04 (3 pcs) L-06 (1 pcs)
Cross dividers, ordered separately (quantity/drawer)	V-00 (5 pcs)	V-01 (5 pcs)	V-02 (5 pcs)	V-04 (5 pcs)	V-06 (5 pcs)	V-07 (5 pcs)	V-01 (5 pcs) V-04 (5 pcs) V-06 (5 pcs)
Length dividers, ordered separately (quantity/drawer)	-	V-012 (1 pcs)	V-012 (3 pcs)	V-0456 (1 pcs)	V-0456 (5 pcs)	V-078 (3 pcs)	V-012 (1 pcs) V-0456 (1 pcs) V-0456 (5 pcs)

Grey frame (RAL7016), crystal clear drawers and self-adhesive labels. Strong polypropylene (PP) frame, shelves made of galvanised steel and drawers made of clear polystyrene (PS).



## Series 290 ESD (Size W x D x H mm: 310 x 180 x 290)

Code ESD	291-4ESD	294-4ESD
Includes drawers of type (quantity/drawer)	L-61-4ESD (24 pcs)	L-64-4ESD (12 pcs)
Cross dividers, ordered separately (quantity/drawer)	V-1-4ESD (5 pcs)	V-4-4ESD (5 pcs)

The frame is made of semiconductive polypropylene (PP), the drawers of semiconductive polystyrene (PS), and the shelves of galvanised steel.





**Series 550** (Size W x D x H mm: 310 x 180 x 550)

Code	550-3	551-3	552-3	554-3	556-3	557-3	550C-3
Includes drawers of type (quantity/drawer)	L-00 (60 pcs)	L-01 (48 pcs)	L-02 (24 pcs)	L-04 (24 pcs)	L-06 (8 pcs)	L-07 (12 pcs)	L-01 (24 pcs) L-04 (6 pcs) L-06 (2 pcs)
Cross dividers, ordered separately (quantity/drawer)	V-00 (5 pcs)	V-01 (5 pcs)	V-02 (5 pcs)	V-04 (5 pcs)	V-06 (5 pcs)	V-07 (5 pcs)	V-01 (5 pcs) V-04 (5 pcs) V-06 (5 pcs)
Length dividers, ordered separately (quantity/drawer)	-	V-012 (1 pcs)	V-012 (3 pcs)	V-0456 (1 pcs)	V-0456 (5 pcs)	V-078 (3 pcs)	V-012 (1 pcs) V-0456 (1 pcs) V-0456 (5 pcs)

Grey frame (RAL7016), crystal clear drawers and self-adhesive labels. Strong polypropylene (PP) frame, shelves made of galvanised steel and drawers made of clear polystyrene (PS).



**Series 550 ESD** (Size W x D x H mm: 310 x 180 x 550)

Code	551-4ESD	554-4ESD
Includes drawers of type (quantity/drawer)	L-61-4ESD (48 pcs)	L-64-4ESD (24 pcs)
Cross dividers, ordered separately (quantity/drawer)	V-1-4ESD (5 pcs)	V-4-4ESD (5 pcs)

The frame is made of semiconductive polypropylene (PP), the drawers of semiconductive polystyrene (PS), and the shelves of galvanised steel.



**+** **Cabinet trolley on page 139.**  
This assembly holds 8 cabinets, which must be ordered separately.



# Spacemisers for small-parts storage cabinets

**Perfect for storage and identification of thousands of small components in retail, manufacturing, workshops and warehousing.** A storage spacemiser holds 12 small-parts storage cabinets from series 550, which must be ordered separately. Owing to its robust base and divider shelf system, the spacemiser retains its cabinets firmly in place and has a load capacity of 400 kg.

Mounted on a ball-bearing base, the unit can be effortlessly rotated for ease of use. This assembly offers storage for up to 4320 different items on a floor area of only 0.25 sqm. The unit is easy to assemble.

## Spacemiser

Size W x D x H mm	Max load kg	Code	Code ESD
500 x 500 x 1730*	400	12-550	12-550 ESD

\*The overall dimensions of a completely assembled unit.

## Bench top spacemiser PTP-5

The product holds 2 small-parts storage cabinets from series 550 or 290 which must be ordered separately. The unit includes a ball bearing base.

## Bench top spacemiser

Size W x D x H mm*	Max load kg	Code	Code ESD
360 x 310 x 300 mm (series 290)*	50	PTP-5	PTP-5 ESD
360 x 310 x 560 mm (series 550) *			

\*The overall dimensions of a completely assembled unit.



ESD bench top spacemiser

# Storage bin cabinets

These cabinets can be wall hung or mounted on turntables, or stood on a work top. This product is available in two depths, 300 and 400 mm.

This product includes a frame, bins and labels with protective shields. Backstops hold the bins when fully extended. The sturdy steel frame has been given a durable powder-coat finish in grey (RAL 7035), and the back of the cabinet includes holes for wall mounting. The bins are of clear polystyrene (PS), coloured polypropylene (PP) or recycled polypropylene (PP).



+

Bins on page 205.



## Storage bin cabinets

Colour	Code	Code	Code	Code
Crystal clear	0830-1	1630-1	0840-1	1640-1
Grey	0830-3	1630-3	0840-3	1640-3
Red	0830-5	1630-5	0840-5	1640-5
Blue	0830-6	1630-6	0840-6	1640-6
ESD	0830 ESD	1630 ESD	0840 ESD	1640 ESD
Includes drawers (type/quantity)	3020 (8 pcs)	3010 (16 pcs)	4020 (8 pcs)	4010 (16 pcs)
Frame width (mm)	400	400	400	400
depth mm	300	300	400	400
height (mm)	395	395	395	395
Cross dividers, ordered separately (quantity/drawer)	D-20 / D-20-4ESD (max. 4 pcs)	D-10 / D-10-4ESD (max. 4 pcs)	D-20 / D-20-4ESD (max. 6 pcs)	D-10 / D-10-4ESD (max. 6 pcs)



## Treston ReBOX storage bin cabinets

	Code	Code	Code	Code
Recycled plastic	6083-30R	6163-30R	6084-30R	6164-30R
Includes drawers (type/quantity)	6320-30R (8 pcs)	6310-30R (16 pcs)	6420-30R (8 pcs)	6410-30R (16 pcs)
Frame width (mm)	400	400	400	400
depth mm	300	300	400	400
height (mm)	395	395	395	395
Cross dividers, ordered separately (quantity/drawer)	620 (max. 4 pcs)	610 (max. 4 pcs)	620 (max. 6 pcs)	610 (max. 6 pcs)

The Treston ReBOX bins are detailed on page 209.

# Spacemisers for storage bin cabinets

1

1 x spacemiser 16-300  
8 x storage bin cabinets 0830  
8 x storage bin cabinets 1630

2

1 x spacemiser 16-400  
8 x storage bin cabinets 1640  
8 x storage bin cabinets 0840



A free-standing spacemiser storage system for stores, production facilities, workshops and warehouses. This assembly holds 16 storage bin cabinets, which must be ordered separately. The sturdy, ball-bearing base has a load capacity of 800 kg. These assemblies offer storage for up to 1792 different items on a floor area of only 0.64 sqm. Easy to assemble – no tools required. The unit includes a ball-bearing base and shelves in four layers. The assembly is made of grey powder-coated steel (RAL 7035).

## Spacemiser

Size W x D x H mm	Max load kg	Storage bin depth mm	Code	Code ESD
700 x 700 x 1680*	800	300	16-300	16-300 ESD
800 x 800 x 1680*	800	400	16-400	16-400 ESD

\*The overall dimensions of a completely assembled unit.



## Retaining bars

Storage bin cabinets are also suitable for use in maintenance vehicles. Retaining bars, to be ordered separately as an accessory, keep the bins in place in a moving vehicle. Retaining bars are suitable for all models.

## Retaining bars

Name	Code
Retaining bar set, 4 pcs	A 400



# High density storage cabinets

High density storage cabinets are suitable for the organisation and sorting of large item quantities at production facilities, warehouses, stores and workshops. One cabinet can offer storage for 336 separate items on a floor area of only 0.25 m<sup>2</sup>. If necessary, the cabinets can be equipped with castors or retaining bars.

This product includes a frame, bins and labels with protective shields. Backstops hold the bins when fully extended. Adjustable feet are provided for fine levelling of the cabinet on uneven surfaces. The load capacity of a cabinet is 240 kg, and that of a single shelf is 30 kg. The frame is made of grey powder-coated steel (RAL 7035). Profiled ends and a welded steel construction contribute to the general robustness of the frame.



+ Bins on page 205.



## High density storage cabinets

Colour	Code	Code
Grey	2440-3	4840-3
Red	2440-5	4840-5
Blue	2440-6	4840-6
ESD	2440 ESD	4840 ESD
Includes drawers (type/quantity)	4020 (24 pcs)	4010 (48 pcs)
Frame depth	410	410
width	605	605
height	870	870
Cross dividers, ordered separately (quantity/drawer)	D-20 / D-20-4ESD (6 pcs)	D-10 / D-10-4ESD (6 pcs)

## Castor set

Name	Size mm	Max load kg	Code	Code ESD
Castor set, 4 pcs	Ø 100	150	PS-LH	PS-LH ESD

## Retaining bars

Name	Code
Retaining bar set, 8 pcs	A-605

Note! High density storage bin cabinets have no ready-made mounting holes on the back.

High density storage cabinet 2440-6 with castor set and retaining bars.



# Shelf bins



Shelf bins are also ideal with shelving cabinets, see page 169.



A series of durable, quality bins. The bin types to choose from are classic plastic (Treston Classic), sustainable wood-based bioplastic (Treston BiOX) and 100% recycled plastic (Treston ReBOX). Shelf bins are designed to fit all standard metric shelves, cabinets, paternosters and industrial workstations.

## Treston Classic shelf bins

The shelf bin product family includes 11 different bin sizes to choose from. Bins of the same width stack securely, even if they are of different lengths. The depth dimensions are 300, 400, 500 and 600 mm, three different widths. Straight sides ensure an efficient use of space, and the bins are available in several bright colours to facilitate product identification. You can see the contents clearly through the transparent bins. Each bin comes with a label and protective cover.



A label with a protective shield is easy to clean and change when necessary. The shield and label is included.



Corrugated base stops items from sliding on the surface and makes picking up small items easy.



Shelf bins are designed to fit all metric shelving systems.

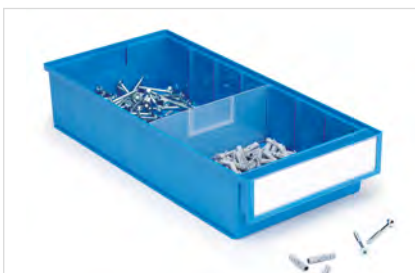

Individual bins can be sub-divided internally using dividers. Dividers are ordered separately.



Space is reserved for labels on the rear surface of drawers and on dividers. Labels are ordered separately.

**Crystal clear**

**Grey,  
RAL 7016**

**Red,  
RAL 3020**

**Blue,  
RAL 5015**

**Black, ESD**
**Treston Classic shelf bins**
**Accessories**

	Material	External dimensions W x D x H mm	Internal dimensions W x D x H mm	Capacity, litres	Quantity/ package	Colour	Code	Cross divider	Max. amount/ bin	Label + cover
	PS	92 x 300 x 82	75 x 257 x 70	1.3	30	Crystal clear	3010-1	D-10	4 pcs.	S-10M
	PP					Grey	3010-3			
	PP					Red	3010-5			
	PP					Blue	3010-6			
	PP					ESD	3010-4ESD			
	PS	92 x 400 x 82	75 x 357 x 70	1.9	30	Crystal clear	4010-1	D-10	6 pcs.	S-10M
	PP					Grey	4010-3			
	PP					Red	4010-5			
	PP					Blue	4010-6			
	PP					ESD	4010-4ESD			
	PS	92 x 500 x 82	75 x 457 x 70	2.4	30	Crystal clear	5010-1	D-10	8 pcs.	S-10M
	PP					Grey	5010-3			
	PP					Red	5010-5			
	PP					Blue	5010-6			
	PP					ESD	5010-4ESD			
	PS	132 x 300 x 100	110 x 257 x 90	2.5	30	Crystal clear	3015-1	D-15	4 pcs.	S-15M
	PP					Grey	3015-3			
	PP					Red	3015-5			
	PP					Blue	3015-6			
	PP					ESD	-			
	PS	132 x 400 x 100	110 x 357 x 90	3.2	20	Crystal clear	4015-1	D-15	6 pcs.	S-15M
	PP					Grey	4015-3			
	PP					Red	4015-5			
	PP					Blue	4015-6			
	PP					ESD	4015-4ESD			
	PP	132 x 500 x 100	110 x 457 x 90	4.5	20	Grey	5015-3	D-15	8 pcs.	S-15M
	PP					Red	5015-5			
	PP					Blue	5015-6			
	PP					ESD	5015-4ESD			
	PP					ESD	5015-4ESD			
	PP	132 x 600 x 100	110 x 557 x 90	5.5	15	Grey	6015-3	D-15	10 pcs.	S-15M
	PP					Red	6015-5			
	PP					Blue	6015-6			
	PP					ESD	6015-4ESD			
	PP					ESD	6015-4ESD			
	PS	186 x 300 x 82	167 x 257 x 70	3.0	15	Crystal clear	3020-1	D-20	4 pcs.	S-20M
	PP					Grey	3020-3			
	PP					Red	3020-5			
	PP					Blue	3020-6			
	PP					ESD	3020-4ESD			
	PS	186 x 400 x 82	167 x 357 x 70	4.2	15	Crystal clear	4020-1	D-20	6 pcs.	S-20M
	PP					Grey	4020-3			
	PP					Red	4020-5			
	PP					Blue	4020-6			
	PP					ESD	4020-4ESD			
	PS	186 x 500 x 82	167 x 457 x 70	5.3	15	Crystal clear	5020-1	D-20	8 pcs.	S-20M
	PP					Grey	5020-3			
	PP					Red	5020-5			
	PP					Blue	5020-6			
	PP					ESD	5020-4ESD			
	PS	186 x 600 x 82	167 x 557 x 70	6.5	15	Crystal clear	6020-1	D-20	10 pcs.	S-20M
	PP					Grey	6020-3			
	PP					Red	6020-5			
	PP					Blue	6020-6			
	PP					ESD	6020-4ESD			

PS = Crystal clear polystyrene: temperature tolerance -40 ...+55°C.

PP = Coloured polypropylene: temperature tolerance -20 ... +75°C, withstands the effects of most oils, acids and solvents.

# Treston BiOX shelf bins



**Treston BiOX is a bio-based storage solution for industrial use.** The material of Treston BiOX bins is over 90% wood-based renewable material, residue from pulp production process, and cellulose fibres. The quality as well as the look and feel of the bins, remains the same as with traditional plastic bins. Treston BiOX bins are ISCC certified.



Looks like plastic, acts like plastic, but it is made of wood-based material.



Corrugated base stops items from sliding on the surface and makes picking up small items easy.



A label with a protective shield is easy to clean and change when necessary. The shield and label is included.



Withstands the effects of oils, most acids and solvents.



Individual bins can be sub-divided internally using dividers. Dividers are ordered separately.



Space is reserved for labels on the rear surface of drawers and on dividers. Labels are ordered separately.

**Treston BiOX shelf bins**

**Accessories**

	External dimensions W x D x H mm	Internal dimensions W x D x H mm	Capacity, litres	Quantity/ package	Color	Code	Cross divider	Max. amount/bin	Label + cover
	92 x 300 x 82	75 x 257 x 70	1,3	30	Green Blue	3010-7 BIOX 3010-6 BIOX	D-10 BIOX	4 pcs	S-10M BIOX
	92 x 400 x 82	75 x 357 x 70	1,9	30	Green Blue	4010-7 BIOX 4010-6 BIOX	D-10 BIOX	6 pcs	S-10M BIOX
	92 x 500 x 82	75 x 457 x 70	2,4	30	Green Blue	5010-7 BIOX 5010-6 BIOX	D-10 BIOX	8 pcs	S-10M BIOX
	186 x 300 x 82	167 x 257 x 70	3,0	15	Green Blue	3020-7 BIOX 3020-6 BIOX	D-20 BIOX	4 pcs	S-20M BIOX
	186 x 400 x 82	167 x 357 x 70	4,2	15	Green Blue	4020-7 BIOX 4020-6 BIOX	D-20 BIOX	6 pcs	S-20M BIOX
	186 x 500 x 82	167 x 457 x 70	5,3	15	Green Blue	5020-7 BIOX 5020-6 BIOX	D-20 BIOX	8 pcs	S-20M BIOX

Bin material: Coloured bioplastic with fiber reinforcement. Temperature tolerance -20 ... +75°C, withstands the effects of oils, most acids and solvents. Due to the wood-based bioplastic material the surface of the bin may show fibers which is completely normal.

Divider material: Transparent wood-based plastic (Woody). Temperature tolerance -20...+50°C, good resistance against oils, moderate or limited resistance against polar solvents and highly acidic or alkaline media. Due to the wood-based bioplastic material the dividers may be slightly blurred.



Green



Blue



# Treston ReBOX shelf bins

Made from 100% recycled plastic, an environmentally friendly and economical range of bins that offer versatile storage. The product family includes 9 different bin sizes to choose from. The depth alternatives are 300, 400 and 500 mm, 3 different widths. Large, white labels come as standard.









Treston ReBOX was formerly named Kennoset.



## Treston ReBOX shelf bins

## Accessories

	Material	External dimensions W x D x H mm	Internal dimensions W x D x H mm	Capacity, litres	Quantity/ package	Code	Cross divider	Max. amount/ bin	Label
	PP	94 x 300 x 80	77 x 260 x 75	1,5	40	6310-30R	610	4 pcs	1778
	PP	94 x 400 x 80	77 x 360 x 75	2,1	40	6410-30R	610	6 pcs	1778
	PP	94 x 500 x 80	77 x 460 x 75	2,7	40	6510-30R	610	8 pcs	1778
	PP	186 x 300 x 80	173 x 260 x 75	3,4	20	6320-30R	620	4 pcs	1778
	PP	186 x 400 x 80	173 x 360 x 75	4,7	20	6420-30R	620	6 pcs	1778
	PP	186 x 500 x 80	173 x 460 x 75	6,0	20	6520-30R	620	8 pcs	1778

PP = Recycled polypropylene: temperature tolerance -20 ... +75°C, withstands the effects of most oils, acids and solvents. Grey, contains small traces of ink residues and the colour tint may vary.

## Treston ReBOX shelf bins, stackable

## Accessories

	Material	External dimensions W x D x H mm	Internal dimensions W x D x H mm	Capacity, litres	Quantity/ package	Code	Cross divider	Max. amount/ bin	Label
	PP	160 x 300 x 85	145 x 240 x 81	2,8	20	6316-30R	616	2 pcs	3190
	PP	160 x 400 x 85	145 x 340 x 81	4,0	20	6416-30R	616	3 pcs	3190
	PP	160 x 500 x 85	145 x 440 x 81	5,2	20	6516-30R	616	4 pcs	3190

PP = Recycled polypropylene: temperature tolerance -20 ... +75°C, withstands the effects of most oils, acids and solvents. Grey, contains small traces of ink residues and the colour tint may vary.



# Stacking bins



Our stacking bins have been designed for daily use in stores, production facilities and warehouses. The bin types to choose from are classic plastic (Treston Classic) and 100% recycled plastic (Treston ReBOX). These bins have been designed to fit all standard metric shelves, paternosters and industrial workstations. Bins of the same width stack securely, even if they are of different lengths. Straight sides ensure an efficient use of space.

## Treston Classic stacking bins

Our product range includes 8 bins of different sizes. The design, with a half-open front, allows excellent visibility and easy access to the bin's contents, making it easy to pick from. The colour options allow a storage system to be designed to meet the customer's requirements. The crystal clear bins are transparent, allowing easy visual identification. Bright colours make finding the right item easy.



The design, with a half-open front, allows excellent visibility and easy access to the bin's contents, making it easy to pick from.



A corrugated base stops items from sliding around on the surface and makes picking them up easier.



Bin rail 700 for stacking and picking bins. Includes screws for wall mounting. The load capacity is 50 kg. Length 700 mm. Made of grey epoxy enamelled steel profile. Stacking bins 1015 - 1930 are all suitable. Ordered separately.



A label with a self-adhesive protective shield is affixed to the front plate of the bin. Such labels are easy to change when necessary. Labels must be ordered separately.



Individual bins can be sub-divided internally using dividers. Steel dividers are powder-coated in a grey finish (RAL 7035). Dividers are ordered separately.



Self-adhesive barcodes can be affixed to the front plate and dividers of a bin.



Crystal clear



Grey,  
RAL 7016



Red,  
RAL 3020



Blue,  
RAL 5015



Black, ESD

Treston Classic stacking bins

Accessories

	Material	External dimensions W x D x H mm	Internal dimensions W x D x H mm	Capacity, litres	Quantity/ package	Colour	Code.	Cross divider	Max. amount/ bin	Label + cover
	PS	105 x 165 x 75	90 x 105 x 65	0.6	60	Crystal clear	1015-1	-	-	E-10
	PP					Grey	1015-3			
	PP					Red	1015-5			
	PP					Blue	1015-6			
	PP					ESD	1015-4ESD			
	PS	149 x 192 x 105	125 x 130 x 90	1.5	45	Crystal clear	1520-1	-	-	E-15
	PP					Grey	1520-3			
	PP					Red	1520-5			
	PP					Blue	1520-6			
	PP					ESD	1520-4ESD			
	PS	149 x 250 x 130	125 x 185 x 115	2.7	30	Crystal clear	1525-1	V-14	1 pc.	E-15
	PP					Grey	1525-3			
	PP					Red	1525-5			
	PP					Blue	1525-6			
	PP					ESD	1525-4ESD			
	PS	186 x 300 x 156	155 x 230 x 140	5.0	24	Crystal clear	1930-1	V-19	1 pcs	E-20
	PP					Grey	1930-3			
	PP					Red	1930-5			
	PP					Blue	1930-6			
	PP					ESD	1930-4ESD			
	PS	186 x 400 x 156	155 x 330 x 140	7.2	24	Crystal clear	1940-1	V-19	3 pcs	E-20
	PP					Grey	1940-3			
	PP					Red	1940-5			
	PP					Blue	1940-6			
	PP					ESD	1940-4ESD			
	PS	186 x 500 x 182	145 x 400 x 165	9.6	12	Crystal clear	1950-1	V-195	3 pcs.	E-20
	PP					Grey	1950-3			
	PP					Red	1950-5			
	PP					Blue	1950-6			
	PP					ESD	1950-4ESD*			
	PP	310 x 400 x 156	270 x 315 x 140	11.9	12	Grey	3040-3	V-30	3 pcs.	E-20
	PP					Red	3040-5			
	PP					Blue	3040-6			
	PP					ESD	3040-4ESD*			
	PP					ESD	3040-4ESD*			
	PP	310 x 500 x 182	270 x 400 x 165	17.8	8	Grey	3050-3	V-30	3 pcs.	E-20
	PP					Red	3050-5			
	PP					Blue	3050-6			
	PP					ESD	3050-4ESD*			
	PP					ESD	3050-4ESD*			

PS = Crystal clear polystyrene: temperature tolerance -40 ... +55°C.

\*) Made to order. Request a quotation.

PP = Coloured polypropylene: temperature tolerance -20 ... +75°C, withstands the effects of most oils, acids and solvents.



**Stacking bin trolley on page 138.**

Up to 112 stacking bins can be attached to one trolley, must be ordered separately

# Treston ReBOX stacking bins

Made from 100% recycled plastic, an environmentally friendly and economical range of bins that offer versatile storage. The product family includes 7 different bin sizes to choose from. An open front makes picking easier, length dividers available for some bin models.







Treston ReBOX was formerly named Kennoset.



## Treston ReBOX stacking bins

## Accessories



	Material	External dimensions W x D x H mm	Internal dimensions W x D x H mm	Capacity, litres	Quantity/ package	Code	Divider	Label
	PP	103 x 160 x 73*	87 x 120 x 65	0,7	20	6547-30R	-	1790
	PP	146 x 250 x 12*	123 x 180 x 120	2,7	20	6546-30R	-	1790
	PP	205 x 340 x 153*	180 x 285 x 140	7,2	12	6545-30R	-	1790
	PP	310 x 500 x 180	270 x 410 x 170	18,8	8	6544-30R	-	1790

\* Bin can be hung on wall-mounted bin rails.

PP = Recycled polypropylene: temperature tolerance -20 ... +75°C, withstands the effects of most oils, acids and solvents. Grey, contains small traces of ink residues and the colour tint may vary.

## Treston ReBOX stacking bins, longitudinally dividable

## Accessories

	Material	External dimensions W x D x H mm	Internal dimensions W x D x H mm	Capacity, litres	Quantity/ package	Code	Length divider	Max. amount/ bin	Label
	PP	230 x 300 x 120	205 x 225 x 110	5,1	12	6323-30R	630-30R	1 pc	3189
	PP	230 x 400 x 150	205 x 325 x 140	9,3	12	6423-30R	640-30R	1 pc	3189
	PP	230 x 500 x 150	205 x 425 x 140	12,2	12	6523-30R	650-30R	1 pc	3189

PP = Recycled polypropylene: temperature tolerance -20 ... +75°C, withstands the effects of most oils, acids and solvents. Grey, contains small traces of ink residues and the colour tint may vary.



# Storage and picking bins

## Treston ReBOX storage bins

Particularly suitable for in-house material flows within factories and warehouses. Material: recycled polypropylene (PP) or semiconductive polypropylene (PP). Standard colour: grey.

External dimensions W x D x H mm	Capacity, litres	Quantity/ package	Code	Code ESD
185 x 490 x 250	12.1	12	1949-30R	1949-4ESD*
310 x 490 x 250	22.6	12	3149-30R	3149-4ESD*

\* Made to order. Request a quotation.



## Picking bins

All of the inner faces are rounded and the front has a distinctive sloping design which facilitates picking. Bins can be hung on the wall on bin rails, or mounted on workbench bin rails. Material: polystyrene (PS). Standard colour: blue RAL 5015.

External dimensions W x D x H mm	Capacity, litres	Quantity/ package	Code blue	Code ESD
99 x 160 x 70	1.1	60	30-1L-6	30-1L-4ESD
198 x 160 x 70	2.2	30	30-2L-6	30-2L-4ESD
198 x 160 x 70*	2.2	30	30-23L-6	30-23L-4ESD

\* includes 2 fixed dividers

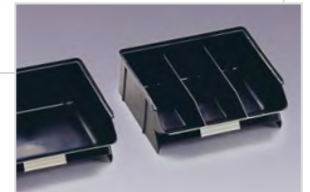

## Bin rail

A wall mounting rail for stacking and picking bins. With fixing screws. Made of grey powder coated steel profile.

Length mm	Max load kg	Code
700	50	700



# Small drawers

Crystal clear drawers come as standard with self-adhesive labels. Cross and length dividers are available as an accessory. The drawers and their dividers are made of crystal clear polystyrene (PS).

## Small drawers

## Accessories

	Material	External dimensions W x D x H mm	Internal dimensions W x D x H mm	Capacity, litres	Quantity/ package	Code	Cross divider	Max. amount/bin	Length divider	Max. amount/ bin
	PS	55 x 175 x 37	47 x 146 x 32	0.2	120	L-00	V-00	5 pcs	-	-
	PS	69 x 175 x 37	61 x 146 x 32	0.3	96	L-01	V-01	5 pcs	V-012	1 pcs
	PS	138 x 175 x 37	128 x 146 x 32	0.6	48	L-02	V-02	5 pcs	V-012	3 pcs
	PS	92 x 175 x 59	82 x 146 x 55	0.7	45	L-04	V-04	5 pcs	V-0456	1 pcs
	PS	277 x 175 x 59	266 x 146 x 55	2.1	15	L06	V-06	5 pcs	V-0456	5 pcs
	PS	138 x 175 x 81	128 x 146 x 74	1.4	24	L-07	V-07	5 pcs	V-078	3 pcs

PS = crystal clear polystyrene

## Small drawers ESD

## Accessories

	Material	External dimensions W x D x H mm	Capacity, litres	Quantity /package	Code ESD	Cross divider	Max. amount/bin
	PS	69 x 170 x 40	0.2	96	L-61-4ESD	V-1-4ESD	5 pcs
	PS	92 x 170 x 62	0.7	45	L-64-4ESD	V-4-4ESD	5 pcs

PS = semiconductive polystyrene

# Stacking bin racks

On BR racks, stacking bins are inclined at a 20-degree angle, enabling the excellent presentation of products. They offer an efficient storage system for daily use when small components are required frequently. This product includes a grey steel frame in an epoxy powder-coated finish and seven fixed, forward-sloping storage levels, 930 mm in width. Stacking bins must be ordered separately.

## Bin rack

Size W x D x H mm	Max load kg	Code
990 x 500 x 1540	350*	BR-2530
990 x 600 x 1670	350*	BR-4050

\*Load capacity 50 kg per level.

## Suitable stacking bins

	Bin code	Quantity/ rail pair	Max. quantity/ rack
Bin rack BR-2530	1525	6 pcs	42 pcs
	1930	5 pcs	35 pcs
Bin rack BR-4050	1940	5 pcs	30 pcs
	1950	5 pcs	30 pcs
	3040	3 pcs	18 pcs
	3050	3 pcs	18 pcs

Details of stacking bins can be found on page 210.



1 x stacking bin rack BR-2530  
35 x red stacking bin 1930-5



1 x stacking bin rack BR-4050  
30 x grey stacking bin 1940-3

# TRESTON

BiOX





# Spare parts

## Arm adapters for MH/MA/MA2/MA4

Profile type	Workbench model	MH	MA	MA2	MA4
C-profiles	TPH, TPB	AS2	AS2	AS2	AS4C
Upright profiles	Concept Ergo, Concept, QuatreX, TED, TP, Heavy duty	AS2	AS2	AS2	AS4

## Arm adapters for Concept Ergo, Concept, QuatreX, TED, Quick Edge, TP and Heavy duty accessories with arms

Profile type	Workbench / trolley model	40 mm arm	60 mm arm
C-profiles	TPH, TPB	-	E824 081-49
AL2X aluminum profiles	WB, QuatreX	890 524-49	890 525-49
Aluminum profiles	WTR	E821 573-49	E821 572-49

## Castors

Name	Compatibility	Screw	Code
Castor set Ø 100	53 drawer unit		852 625-00
Castor set Ø 100 ESD	53 drawer unit		890 785-00
Castor set Ø 100	45 drawer units, Storage trolley	M10	852 768-00
Castor set Ø 100	Fitter's trolley, Concept and TP benches	M12	834 734-00
Castor set Ø 100 ESD	45 drawer units, Storage trolley	M10	852 774-00
Castor set Ø 100 ESD	Concept and TP benches	M12	860 429-00
Castor set Ø 100	WB, QuatreX and Quick Edge benches, TED desk	M10	LCS100
Castor set Ø 100 ESD	WB, QuatreX and Quick Edge benches, TED desk	M10	LCS100 ESD
Castor set Ø 100	Concept Ergo	M10	LCS100CE
Castor set Ø 100 ESD	Concept Ergo	M10	LCS100CE-ESD
Castor set Ø 125	TRTA trolley		LCS125
Castor set Ø 125 ESD	TRTA trolley		LCS125 ESD
Castor set Ø 50	Transport skate	M10	853 176-00
Castor set Ø 50 ESD	Transport skate ESD	M10	853 175-00
Fixed castor Ø 150	Service trolley		900 537-00
Swivel castor Ø 100	Service trolley		942 060-00
Swivel castor Ø125, brake	Treston Industrial Multii trolley	M10	10019-00
Swivel castor Ø125	Treston Industrial Multii trolley	M10	10021-00
Swivel castor Ø125 ESD, brake	Treston Industrial Multii trolley ESD	M10	10022-00
Swivel castor Ø125 ESD	Treston Industrial Multii trolley ESD	M10	10020-00
Support castor Ø 100	Tool storage system		943 690-00
Swivel castor Ø100	Heavy duty bench leg, Treston Tower, Heavy duty trolley		1987
Fixed castor Ø100	Heavy duty bench leg, Treston Tower, Heavy duty trolley		1988
Swivel castor Ø100	SAP trolley	M10	E100 NKM
Swivel castor Ø100 ESD	SAP trolley ESD	M10	E100 NK AM ESD
Swivel castor Ø100, brake	SAP trolley	M10	EJ100 NKM
Swivel castor Ø100 ESD, brake	SAP trolley ESD	M10	EJ100 NK AM ESD

## Spare parts for industrial cabinets

Name	Compatibility	Code
Rubber mat 550 x 420	Industrial cabinet 55/100	836 716-00
Rubber mat 799 x 420	Industrial cabinet 80/100	836 715-00

**Drawer unit spare parts**

Name	Size W x D x H	Compatibility	Code
Cover with an ESD mat, assembled*	450 x 518 x 14	45 drawer unit	W87 2107-49
Cover with a rubber mat, assembled*	450 x 518 x 14	45 drawer unit	W87 2107-41
Cover without mat	450 x 518 x 14	45 drawer unit	872 107-49
ESD mat, light grey	445 x 513	45 drawer unit cover	836 750-00
Rubber mat, black	445 x 513	45 drawer unit cover	836 740-00
Shelf for cabinet version		45 drawer unit	872 043-49
Bracket pair for the shelf		45 drawer units	872 045-51
Castor set Ø 100 ESD		45 drawer units	852 774-00
Base		53 drawer unit	726 354-49
Top cover		53 drawer unit	726 258-49
Rubber mat for drawer unit's cover	525 x 635	53 drawer unit	723 124-00
ESD mat for drawer unit's cover	525 x 635	53 drawer unit	726 516-49
Trolley set 53/66 (castors, cover & handle)		53 drawer unit	854 180-41
Top cover 70	715 x 736	70 drawer unit	726 894-49
Top cover 90	910 x 736	90 drawer unit	726 893-49
Top cover 130	1330 x 736	130 drawer unit	726 863-49
Rubber mat for cover	708 x 736	70 drawer unit	834 951-00
Rubber mat for cover	906 x 736	90 drawer unit	834 953-00
Rubber mat for cover	1322 x 736	130 drawer unit	834 954-00

\*Factory assembly to ordered drawer unit. Not to be sold separately.

**Drawer interior parts for drawer unit 45**

Name	Compatibility	Code
Vertical divider	45/100 drawer	872 300-49
Vertical divider	45/150 and 45/200 drawers	872 301-49
Divider plate L=125	45/100 drawer	872 302-49
Divider plate L=185	45/100 drawer	872 303-49
Divider plate L=250	45/100 drawer	872 304-49
Divider plate L=375	45/100 drawer	872 305-49
Divider plate L=125	45/150 and 45/200 drawers	872 306-49
Divider plate L=185	45/150 and 45/200 drawers	872 307-49
Divider plate L=250	45/150 and 45/200 drawers	872 308-49
Divider plate L=375	45/150 and 45/200 drawers	872 309-49
Divider holder set for drawer interiors (incl. 12 pcs)		853 003-00

**Drawer interior parts for drawer units 53, 70, 90 and 130**

Name	Compatibility	Code
Divider, L=600	For drawer height 75	872 310-49
Divider, L=600	For drawer height 100	872 311-49
Divider, L=600	For drawer height 150&250	872 312-49
Middle plate, L=100	For drawer height 75	832 525-49
Middle plate, L=150	For drawer height 75	832 526-49
Middle plate, L=300	For drawer height 75	832 527-49
Middle plate, L=100	For drawer height 100	832 528-49
Middle plate, L=150	For drawer height 100	832 529-49
Middle plate, L=300	For drawer height 100	832 530-49
Middle plate, L=100	For drawer height 150 & 250	832 533-49
Middle plate, L=150	For drawer height 150 & 250	832 531-49
Middle plate, L=300	For drawer height 150 & 250	832 532-49
Middle plate holder set, 12 pcs		853 003-00
Divider side holder 75	For drawer height 75	854 282-49
Divider side holder 100	For drawer height 100	854 264-49
Divider side holder 150	For drawer height 150 & 250	854 265-49
Tool trough 150/4	150x150 mm, 4x33 wide troughs	837 460-00
Tool trough 150/3	150x150 mm, 3x45 wide troughs	837 450-00
Tool trough 150/2	150x150 mm, 2x70 wide troughs	837 430-00
Middle plate, tool troughs, 33 mm	For tool trough 150/4	837 490-00
Middle plate, tool troughs, 45 mm	For tool trough 150/3	837 480-00
Middle plate, tool troughs, 70 mm	For tool trough 150/2	837 470-00
Pick-up box 149 x 85 x 48 mm		851 843-00

## Spare parts labels for plastic bins, dividers and small drawers

Name	Size W x H mm	Min. order quantity	Compatibility	Code
Label for bin	82 x 41	15 pcs	3010...5010-1/-3/-5/-6, 3010...5010-4ESD, 3010, 4010, 5010-7 BIOX	1868
Label for bin	12 x 41	15 pcs	3015...6015-1/-3/-5/-6, 3015...6015-4ESD	3532
Label for bin	176 x 41	15 pcs	3020...6020-1/-3/-5/-6, 3020...6020-4ESD, 3020, 4020, 5020-7 BIOX	1123
Label for bin	77 x 26	12 pcs	1949-30R, 1949-4ESD, 3149-30R, 3149-4ESD, 6546-30R, 6545-30R, 6544-30R	1789
Label for bin	85,5 x 36,5	40 pcs	6310-30R, 6410-30R, 6510-30R, 6320-30R, 6420-30R, 6520-30R	1778
Label for bin	57 x 18	20 pcs	6547-30R	1790
Label for bin	135 x 48	8/A4	6316-30R, 6416-30R, 6516-30R	3190
Label for bin	100 x 48	12/A4	6323-30R, 6423-30R, 6523-30R	3189
Label for cross divider	59 x 30	20 pcs	D-10, D-15, D-20, D-10-4ESD, D-15-4ESD, D-20-4ESD, D-10 BIOX, D-20 BIOX	1792
Label for cross divider	137 x 34	20 pcs	616	1828
Label for small drawer	42 x 15,5	95/A4	L-00, 30-11L-6, 30-11L-4ESD, 30-21L-6, 30-21L-4ESD, 30-23L-6, 30-23L-4ESD	3195
Label for small drawer	52,5 x 15,5	76/A4	L-01, L-02	3196
Label for small drawer	70 x 24,6	36/A4	L-04, L-06	3197
Label for small drawer	52,5 x 22,7	52/A4	L-07	3198
Label for small drawer	65,5 x 17	12 pcs	L-61-4ESD	1119
Label for small drawer	86,5 x 25	12 pcs	L-64-4ESD	1120



# Download **free eBooks**



## Increasing productivity with proper ergonomics

This informational e-book will help you learn how ergonomic environments can have a direct influence on employee well-being, the reduction of time and waste, and ultimately, greater productivity.



## How to build an ESD-protected area that actually works

Setting up an ESD-protected area (EPA) is easier than ever. With the right plan, furniture, and practices, you can protect products, improve reliability, and reduce costly returns.



## LEAN thinking perfects production processes

This e-book will help you understand LEAN philosophy and how Treston, as a manufacturer of technical facilities and ergonomic furniture, can help you with the LEAN thinking to perfect your production processes.

These and more educative and useful e-books available on our website:

[treston.com/catalogues-and-brochures](http://treston.com/catalogues-and-brochures)



## Product animations, informational videos and more!

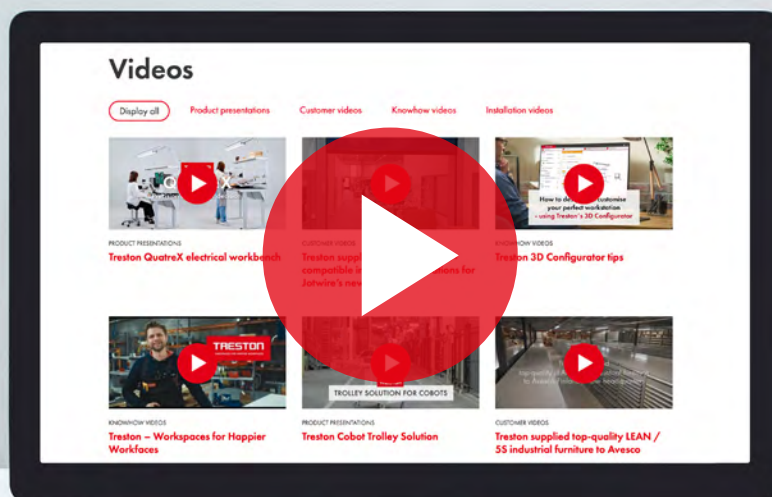

[treston.com/videos](http://treston.com/videos)

# What our customers say



**"Several competitor products we viewed didn't give us the same level of confidence, modularity and robustness"**

– David Walch, Operations Director,  
FT Technologies

## CHRISTIE'S

**"Treston was a great partner in designing a custom packing bench and worktable solution for Christie's."**

– Emily Sarokin,  
Christie's Auction House NYC



**"The two most important goals were ergonomics and efficiency. This we have reached by using Treston."**

– Lisanne Broer-van Abeelen,  
bol.com fulfilment center



**"Thank you for the informative day at Treston. Your great team impressed me with their knowledge."**

– M. Huber, Kaiserslautern,  
SKS Welding Systems GmbH



**"SNCF chose Treston for high quality, ergonomics and modularity enabling future modifications ."**

– David Lacour, Head of Proximity  
Tachometry, SNCF Mobility

**Read all our customer stories at:**

[treston.com/about-us/  
customer-stories](https://treston.com/about-us/customer-stories)

## HEADQUARTERS & FACTORIES

Treston Oy  
Headquarters and Turku plant  
Sorakatu 1  
FI-20730 Turku  
Tel. +358 10 4469 11  
sales@treston.com  
www.treston.fi

Treston Oy  
Jyväskylä plant  
PO Box 33 (Sohlberginkatu 10)  
FI-40351 Jyväskylä  
Tel. +358 10 4469 11  
sales@treston.com  
www.treston.fi

## GERMANY

Treston Deutschland GmbH  
Friedrich-Ebert-Damm 143  
22047 Hamburg  
Tel. +49 40 8816 5022 - 0  
info.de@treston.com  
www.treston.de

Treston Deutschland GmbH  
Niederlassung Raunheim  
Frankfurter Straße 101  
65479 Raunheim  
Tel. +49 6142 992 50  
mail.de@treston.com  
www.treston.de

## FRANCE

Treston France SARL  
Z.A.C. de la Bonne Rencontre  
1, voie Gallo Romaine, Quincy-Voisins  
77334 Meaux Cedex  
Tel. +33 1 64 17 11 11  
infofr@treston.com  
www.treston.fr

## SWEDEN

Treston AB  
Polygonvägen 73  
187 66 Täby  
Tel. +46 8 511 791 60  
info.se@treston.com  
www.treston.se

## USA

Treston IAC LLC  
USA Headquarters / Factory  
3831 S Bullard Ave,  
Goodyear, AZ 85338  
Tel. +1 714-990-8997  
infousa@treston.com  
www.treston.us

Treston IAC LLC  
USA Distribution  
156 Bluffs Court  
Canton, GA 30114  
Tel. +1 770-721-7980  
infousa@treston.com  
www.treston.us

## UNITED KINGDOM

Treston Ltd  
Treston House  
5b Bone Lane, Newbury  
Berkshire, RG14 5SH  
Tel. +44 1635 521521  
salesuk@treston.com  
www.treston.com

## PREMIUM PARTNERS:

### BENELUX

Human Workspace BV  
Mechelaarstraat 17  
4903 RE Oosterhout  
Tel. +31 162 454 383  
sales@humanworkspace.nl  
www.humanworkspace.nl

### NORWAY

Industrimøbler AS  
Bjørnerudveien 12A  
1266 Oslo  
Tel. +47 22 25 05 00  
post@industrimobler.no  
www.industrimobler.no

### SPAIN

Technology & Chemical S.L. - Cadiz  
Recinto Interior Zona Franca  
Edificio Atlas Mod. B-01, B-08, B-09  
11011 Cadiz  
Tel. +34 956 20 11 12  
tch@tch.es  
www.trestonespaña.es



Thanks to our global sales network, you can receive local support and customer service anywhere in the world.

Find your nearest retailer: [www.treston.com/contact-us](http://www.treston.com/contact-us)

# TRESTON

## Workspaces for happier workfaces.

This is our aspiration. This is our promise. This is what Treston is all about.

With decades of experience, in-depth understanding of ergonomics in industrial environments, unmatched ESD competence and proven LEAN knowhow we at Treston are in a unique position to help our customers in keeping their business and people in good shape.

[treston.com](http://treston.com)

## CHRISTIE'S

"Treston was a great partner in designing a custom packing bench and worktable solution for Christie's."

– Emily Sarokin,  
Christie's Auction House NYC



"Treston solutions' simple shape and colour and the ergonomic features make working easy and pleasant."

– Thorsten Timmermann,  
Sennheiser